

**FINAL REPORT
LOW-TEMPERATURE RESOURCE
ASSESSMENT PROGRAM**

February 1996

**FINAL REPORT
LOW-TEMPERATURE RESOURCE ASSESSMENT PROGRAM**

**Paul J. Lienau
Geo-Heat Center
Oregon Institute of Technology**

**Howard Ross
Earth Sciences and Resources Institute
University of Utah**

**Geo-Heat Center
Oregon Institute of Technology
3201 Campus Drive
Klamath Falls, OR 97601**

Prepared for:

Lockheed Idaho Technologies Company under subcontracts C97-120253 (Oregon Institute of Technology) and C87-101314 (University of Utah, Earth Sciences and Resources Institute) and for the U.S. Department of Energy, Assistant Secretary for Energy Efficiency and Renewable Energy, Geothermal Division, under DOE Idaho Operations Office Contract DE-AC07-94ID13223 (Lockheed Idaho Technologies Company).

February 1996

DISCLAIMER STATEMENT

This report was prepared with the support of the U.S. Department of Energy, Assistant Secretary for Energy Efficiency and Renewable Energy, Geothermal Division, for Lockheed Idaho Technologies Company under subcontracts C97-120253 (Oregon Institute of Technology) and C87-101314 (University of Utah, Earth Sciences and Resources Institute) under DOE Idaho Operations Office Contract DE-AC07-94ID13223. Any opinions, findings, conclusions, or recommendations expressed herein are those of the author(s) and do not necessarily reflect the view of DOE.

ACKNOWLEDGEMENTS

Data compilation and analysis for this report were provided by: G. Black, Oregon Department of Geology and Mineral Industries; R. E. Blackett, Utah Geological Survey; J. A. Cappa, Colorado Geological Survey; W. J. Dansart, J. D. Kauffman and L. J. Mink, Idaho Water Resources Research Institute; L. J. Garside, Nevada Bureau of Mines and Geology; J. Metesh and W. Van Voast, Montana Bureau of Mines and Geology; J. E. Schuster, Washington Division of Geology and Earth Resources; G. Bloomquist, Washington State Energy Office; J. C. Witcher, New Mexico State University and L. G. Youngs, California Division of Mines and Geology. Their contributions are gratefully acknowledged. We also wish to acknowledge T. Boyd, Geo-Heat Center, for collocated resources database and maps, K. Rafferty for work on geothermal cost evaluation, and D. Gibson for typing this report.

ABSTRACT

The U.S. Department of Energy - Geothermal Division (DOE/GD) recently sponsored the Low-Temperature Resource Assessment project to update the inventory of the nation's low- and moderate-temperature geothermal resources and to encourage development of these resources. A database of 8,977 thermal wells and springs that are in the temperature range of 20°C to 150°C has been compiled for ten western states, an impressive increase of 82% compared to the previous assessments. The database includes location, descriptive data, physical parameters, water chemistry and references for sources of data. Computer-generated maps are also available for each state. State Teams have identified 48 high-priority areas for near-term comprehensive resource studies and development. Resources with temperatures greater than 50°C located within 8 km of a population center were identified for 271 collocated cities. Geothermal energy cost-evaluation software has been developed to quickly identify the cost of geothermally supplied heat to these areas in a fashion similar to that used for conventionally fueled heat sources.

TABLE OF CONTENTS

EXECUTIVE SUMMARY	1
Background	1
State Resource Evaluation, Inventory and Recommendations	2
Collocated Resources	5
Geothermal Energy Cost Evaluation	5
Conclusions and Recommendations	6
INTRODUCTION	8
Background	8
Direct-Heat Applications	9
Previous Compilation of Data on Hydrothermal Resources	13
Descriptive Data and Fluid Chemistry	14
STATE RESOURCE EVALUATION, INVENTORY AND RECOMMENDATIONS ...	16
Arizona	17
California	19
Colorado	20
Idaho	21
Montana	22
Nevada	23
New Mexico	24
Oregon	25
Utah	26
Washington	27
COLLOCATED RESOURCES	29
GEOHERMAL ENERGY COST EVALUATION	30
REFERENCES	34
APPENDIX A - Database of Collocated Resources	
APPENDIX B - State Maps of Collocated Resources	
APPENDIX C - State Team Principal Investigators	

LIST OF TABLES

Table 1.	Annual Energy Supplied for Major Direct-Heat Applications.	10
Table 2.	State Geothermal Database, Data Field Summary	15
Table 3.	State Geothermal Database Summary: 1992-95 Low- Temperature Program	17

LIST OF FIGURES

Figure 1.	Geographic extent of the new resource assessment identified in bold outlines.	8
Figure 2.	Growth of the U.S. geothermal direct-heat industry	10
Figure 3.	Geothermal direct heat system - open distribution	12
Figure 4.	Geothermal direct heat system - closed distribution	12
Figure 5.	Spreadsheet for a geothermal system and gas boiler plant	30
Figure 6.	Cost effectiveness of geothermal vs. natural gas for a 3 MWt (10,000,000 Btu/hr) load with one production well.	32
Figure 7.	Cost effectiveness of geothermal vs. natural gas for a 6 MWt (20,000,000 Btu/hr) load with two production wells.	33

FINAL REPORT LOW-TEMPERATURE RESOURCE ASSESSMENT PROGRAM

EXECUTIVE SUMMARY

Background

The purpose of this summary is to present an overview of the findings from the 10-state low-temperature geothermal resource assessment program from 1992 to 1995. The previous major effort in assessing the national potential of low-temperature geothermal resources occurred in the early 1980s. This effort resulted in geothermal resource maps produced by the National Geophysical Data Center that depicted low-temperature resource locations including thermal springs and wells. Since that time, substantial new resource information has been gained, but there had been no significant effort to compile all available information on low-temperature resources until the study reported here. To expand utilization of the large direct-heat resource base, a current inventory of these resources is needed by potential users, together with the information necessary to evaluate the reservoirs and the economics of potential uses.

Products of the new resource assessment include an updated resource map, a descriptive final report, and a digital database for each of 10 western states. The databases developed by State Geothermal Resource Assessment Teams (State Teams) are designed for use on personal computers, and have the capability of being accessed and managed using readily available commercial spreadsheets or data management software. The format is comprised of two general divisions including descriptive information (16 fields) and fluid chemistry (20 fields). Users of the databases can select a great variety of search and sort parameters using standard personal computer database management software to choose those records of interest from the database.

An important part of the assessment was to complete a statewide study of collocated geothermal resources and communities in the western states in order to identify and encourage those communities to develop their geothermal resources. In an earlier collocation effort, Allen (1980) inventoried eight western states to identify cities located within 8 km of a thermal well or spring having a temperature of 10°C or greater. In this study, the ten State Team databases were searched for all the wells and springs with temperatures greater than or equal to 50°C and within 8 km of a community. From that list a Paradox database was compiled containing 18 data fields. The information included within the data fields are the collocated city, latitude and longitude, resource temperature, number of wells within the area, typical depth, total flow for all the resources within the area, current use, weather data and economic development agency contacts in the area.

In order to be seriously considered as an alternative in any project, an energy source must be easily characterized in terms of cost, both capital cost and unit-energy cost. Historically, this has been a difficult hurdle for geothermal energy, whose costs vary with the depth and character

of the resource, number of production and injection wells, and a host of other parameters. As a result, even in cases where developers are interested in using the geothermal energy, identifying its costs has been a cumbersome process. To address this problem, a spreadsheet was developed which allows potential users to quickly evaluate the capital cost and unit-energy cost for developing a geothermal resource (Rafferty, 1995).

State Resource Evaluation, Inventory and Recommendations

The State Teams reviewed essentially all available sources of information on water wells and geothermal literature to arrive at the new inventory. The most productive sources of information included the USGS's on-line water information system known as the National Water Data Storage and Retrieval System, or WATSTORE, the 1983 USGS database file GEOTHERM, and previous state geothermal resource maps. State agency files of water well records submitted by drillers were key data sources for some states, as were open-file and published reports by state agencies. In summary, State Teams identified 900 distinct hydrothermal resource areas some of which may be less than 1 km² in areal extent (fault controlled resources), and extensive thermal aquifers such as the Snake River Plain aquifer or Columbia Plateau aquifer. Brief state summaries and recommendations for high-priority resource studies areas follow:

Arizona

The new geothermal database for Arizona totals 1,251 discrete thermal wells or springs and 2,650 chemical analyses for these 1,251 sites. Witcher (1995a) noted that almost all of Arizona wells and springs found in Arizona at elevations below 1,524 m mean-sea level (5,000 feet) exceed 20°C. Accordingly, the new database is restricted to thermal wells and springs exceeding 30°C, except for a few sites at higher elevations. Witcher (1995a) also noted, that most thermal well occurrences are located along the trend of lower heat flow, where many irrigation wells tap deep-seated aquifers that are overlain by thermally-insulating, low thermal-conductivity sediments in highly-developed agricultural areas. He notes that in Arizona the thermal fluids are more valued for irrigation of field crops, municipal water supply and industrial uses than for the heat carried by the waters. Geothermal aquaculture is the only major direct-use application, and Arizona leads the nation in this use of geothermal fluids. There is considerable potential for direct-heat utilization in the agricultural sector. Recommendations include establishing a strong in-state advocate for direct-use geothermal applications. Key parameters need to be determined for successful aquaculture and greenhousing specifically for Arizona, and detailed feasibility studies need to be completed for these uses.

California

The new California low-temperature database lists 989 thermal wells and springs, a 56% increase over entries reported in 1980. Youngs (1994) estimates that there may be 58 distinct low-temperature resource areas, and an additional 194 "singular" thermal occurrences. These resources occur in volcanic terranes in northern California, in the Basin and Range Province in

the northeastern part of the state, within the Long Valley caldera, and along faults in the sedimentary basins in southern California. Youngs (1994) has identified 56 communities that are located within 8 km of a geothermal resource that has a reported temperature greater than 50°C. The total population collocated with these resources exceeds 2 million people, thus the potential for expanded direct use in the near term is great. Youngs (1994) recommended seven areas for comprehensive resource studies and a technical feasibility study for one area.

Colorado

The new database for Colorado includes 157 thermal wells and springs, a 25% increase over entries reported in 1980. A total of 382 geochemical analyses was compiled for these sites. Cappa and Hemborg (1995) identified 93 geothermal areas, each generally less than 8 km² in size. The great majority of the geothermal areas occurs west of the Front Range within the Rocky Mountain Province. Recommended R&D activities include the compilation of oil and water-well data, geological and geophysical studies, thermal gradient drilling, water sampling and fluid geochemistry for six areas.

Idaho

Dansart, et al. (1994) have compiled a database of 1,537 thermal wells and springs, a 71% increase over entries reported in 1980 and 54 resource areas are described. Geothermal resource areas occur throughout the state, except the northernmost panhandle. The geologic setting of the hydrothermal occurrences varies greatly, including fault and fracture-controlled resources of the Idaho batholith, fault-controlled reservoirs of the northern Basin and Range Province, the Island Park-Yellowstone caldera complex, and the extensive volcanic reservoirs of the Snake River Plain. Dansart, et al. (1994) recommended site-specific studies for nine geothermal resource areas, conceptual and numerical models (2 areas), geologic, geophysical, drilling and feasibility studies (7 areas).

Montana

The Montana geothermal database includes 267 distinct thermal wells and springs (Metesh, 1994). Sixteen resource areas and more than 100 isolated thermal occurrences are reported. Thermal wells and springs occur throughout all areas of Montana but mainly (152 of 267) in the western third of the state (the Northern Rocky Mountains). The plains of the eastern two-thirds of the state host 115 of the 267 thermal sites. About 77 percent of the geothermal sites have measured water temperatures less than 40°C; but, 12 percent have temperatures greater than 50°C. Metesh (1994) identified five geothermal resources collocated with communities and recommended them as priority study areas needing geophysical exploration and deep drilling (1 area), detailed temperature, fluid chemistry and a feasibility study (1 area), deep drilling and a feasibility study (1 area), and resource studies (2 areas).

Nevada

The 1994 Nevada geothermal database contains 457 representative thermal wells and springs from a much larger (>2,000) candidate list to represent the geothermal resources. Essentially all of Nevada lies within the Basin and Range Province, an area of crustal extension

which has remained geologically active since the mid-Miocene. In east-central and southern Nevada, the low- to moderate-temperature resources may be related to regional groundwater circulation in fractured carbonate-rock aquifers (Garside, 1994). Several communities collocated with geothermal resources have good potential for space heating, district heating and industrial processing. Recommended studies to expedite geothermal utilization include data compilation, geological and geophysical surveys, water chemistry, and feasibility studies.

New Mexico

The new geothermal database for New Mexico contains 359 discrete thermal wells and springs, a 15% increase over entries reported in 1980. The database includes 842 chemical analyses for the 359 wells and springs. At least 29 different resource areas and perhaps 151 isolated thermal occurrences have been identified. Almost all of the thermal occurrences are located in the western half of the state, within the Colorado Plateau, Basin and Range, and Rocky Mountains physiographic provinces (Witcher, 1995b). New Mexico has had significant direct-use geothermal development since the early 1980s, with a large district heating system at New Mexico State University, and the largest acreage of geothermal greenhouses in the nation. At present there is considerable interest in the use of geothermal heat for greenhousing, aquaculture, crop and food processing and milk and cheese processing. Witcher (1995b) has identified eight resource areas with near-term utilization potential which need site-specific geologic, drilling, reservoir testing, and feasibility studies.

Oregon

The Oregon Department of Geology and Mineral Industries (DOGAMI) compiled a database of 2,193 thermal wells and springs, an increase of 140% over the 1982 compilation (Black, 1994). These thermal wells and springs may represent more than 200 resource areas. The study concluded that the entire state east of the Cascade Range, except for the crest of the Willowa Mountains, was favorable for the discovery at shallow depth (< 1,000 m) thermal water of sufficient temperature for direct-heat applications. Thermal fluids of 89° to 99°C are used for district heating systems in Klamath Falls. Other uses include space heating at a large number of sites, greenhouse heating, aquaculture, and resorts/spas. Five areas have been recommended for high priority studies to support near-term utilization of thermal fluids. Geophysical studies to define faults and a district heating feasibility study are recommended for one area. Feasibility studies are recommended to assess the economics for space heating, greenhouse heating, and aquaculture projects at four other areas.

Utah

Blackett (1994) lists 792 thermal wells and springs in the new Utah database, a 151% increase over the assessment in the 1980 compilation. He estimates there are 161 different hydrothermal resource areas. Utah comprises parts of three major physiographic provinces, the Colorado Plateaus, the Middle Rocky Mountains and the Basin and Range. Hydrothermal resources with temperatures greater than 50°C occur in each province, and in the Transition Zone between the Basin and Range and Colorado Plateau in central Utah. Commercial greenhouses use thermal water for space heating at Newcastle in Iron County, and at Crystal Hot Springs in

Salt Lake County. Ten resorts use thermal waters for swimming pools, spas and baths. Seven geothermal areas in Utah are recommended for additional studies. Slim hole drilling, geohydrologic studies and numerical modeling of fluid flow and heat transfer are needed in one area. Four other areas need hydrologic and space heating feasibility studies. A limited exploration program is needed at two areas to determine resource potential.

Washington

Schuster and Bloomquist (1994) have compiled a resource database which includes 975 thermal wells and springs, an increase of 165% over the number of entries reported in 1981. Most of the thermal springs occur in the Cascade Range, associated with stratovolcanoes. In contrast 97% of the thermal wells are located in the Columbia Basin of southeastern Washington. These thermal wells are strongly associated with the Columbia River Basalt Group and the Columbia Basin. Rather than prioritize limited areas within this region for detailed studies, Schuster and Bloomquist (1994) make three recommendations for greatly expanding geothermal use in the state. The recommendations are: (1) match existing thermal wells with proposed retrofit or new construction, (2) measure temperature gradients, obtain well-test data and drill cuttings, and collect water samples for chemical analysis, and (3) inform state residents and policy makers about uses of geothermal energy.

Collocated Resources

The collocation study identified **271** cities and communities **with a population of 7.4 million** in the 10 western states that could potentially utilize geothermal energy for district heating and other applications. A collocated community is defined as being within 8 km of a geothermal resource with a temperature of at least 50°C. Over 1,900 thermal wells were identified by State Teams as having temperatures greater than or equal to 50°C and **1,469 are collocated with communities**. From the list, a Paradox database was compiled which contains 18 data fields on the collocated city, population, location, resource temperature, number of wells within the area, typical depth, total flow, total dissolved solids, current use, weather data and contacts for County Economic Development Agencies.

Geothermal Energy Cost Evaluation

It is important to characterize the energy sources for the sites identified by the State Teams in terms of capital cost and unit energy cost. This will aid developers in determining the relative economic merit of geothermal energy. Geothermal energy costs vary with depth and character of the resource, number of production and injection wells, and many other parameters. Software has been developed to quickly identify the cost of geothermally supplied heat in a similar fashion to that used for conventionally fueled heat sources.

Conclusions and Recommendations

Low- and moderate-temperature geothermal resources are widely distributed throughout the western and central United States. Since the last major effort in assessing the national potential of these resources in the early 1980s, there has been a substantial increase in direct-heat utilization. However, the large resource base is still greatly under-utilized. To encourage expanded utilization of low-temperature geothermal resources, a current inventory of these resources has been developed.

State geothermal resource teams (State Teams) evaluations and compilations have resulted in the cataloging of 8,977 thermal wells and springs for 10 western states, an increase of 82% over the previous geothermal assessment in 1983. More than 50 high-priority resource study areas have been identified, along with high potential for near-term direct-heat utilization at 271 collocated sites. Many currently developed geothermal resource areas are characterized by concentrations of tens to hundreds of wells (Reno, NV - 300; Boise, ID - 24; Klamath Falls, OR - 550).

Conservatively assuming that just one average geothermal well is placed in service on each of 1900 resource sites greater than 50°C identified in this work, the impact of geothermal energy's contribution to the national energy supply would be staggering. Installed capacity would increase 780% to 3,340 MW, and annual energy supplied would increase 470% to 26,000 TJ/yr. These impressive results will not be achieved without the continued support for and advocacy of direct-heat geothermal energy-development and use by the Department of Energy.

Although this compilation of resource data indicates the tremendous potential for expanded utilization, many high-priority areas need further resource and engineering studies. More specifically, for 48 high-priority sites these include:

- Geophysical exploration (10 sites)
- Confirmation drilling (12 sites)
- Hydrologic testing (11 sites)
- Comprehensive assessment (8 sites)
- District heating feasibility (12 sites)
- Industrial heating feasibility (7 sites)

We recommend a Phase 2 Low-Temperature Program, funded by DOE, to complete these studies. It is most important to support and maintain a local geothermal expertise (i.e., a State Team) to provide resource information and initial guidance to developers, in each of these states.

In addition, the states of Alaska, Hawaii, Nebraska, North Dakota, South Dakota, Texas and Wyoming need to update their low-temperature resource assessments and to establish new digital databases.

In the future, we hope to continue R&D on improving methods for locating low- and moderate-temperature geothermal resources and on siting successful test and production wells. Part of this work will encompass development of better well-testing methods and better hydrologic models of these hydrothermal resources. These tasks are expected to pay off in further discoveries of resources and in better methods to evaluate reservoir production and ultimate-development capacity at an earlier stage in the development cycle than is now possible. This will further stimulate development of this greatly under-utilized, environmentally-benign resource.

INTRODUCTION

Background

Low- and moderate-temperature geothermal resources are widely distributed throughout the western and central United States. Numerous resources occur in the areas indicated in Figure 1, with individual reservoir areas 1-to-10 square miles in extent. In the northern Great Plains, major aquifers with fluid temperatures exceeding 50°C extend in a continuous manner for thousands of square miles. In addition, geothermal resources also occur at certain locations in the East.

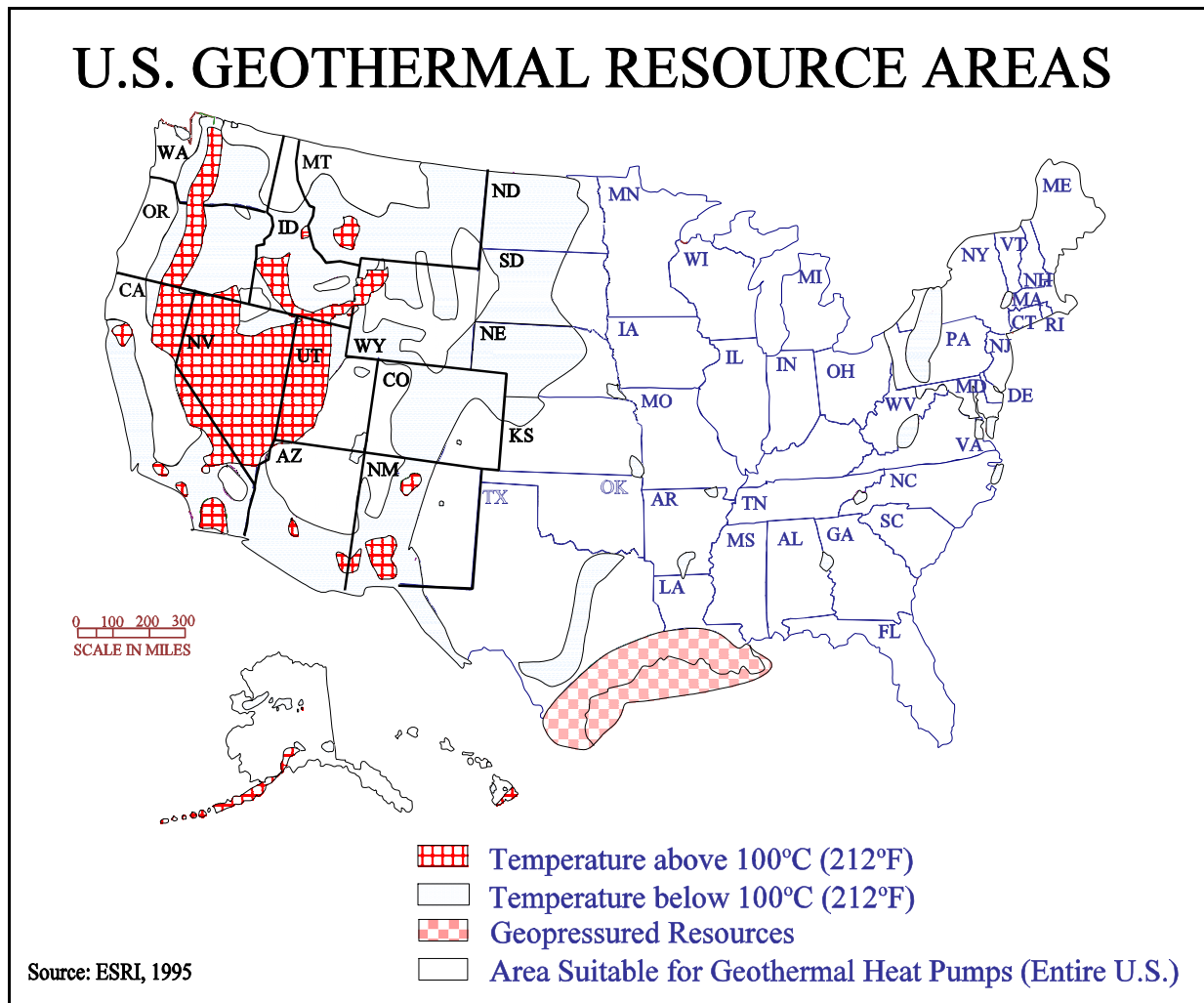

Figure 1. Geographic extent of the new resource assessment identified in bold outlines.

The last major effort in assessing the national potential of low-temperature geothermal resources occurred in the early 1980s (Reed, 1983). Since that time, substantial resource information has been gained through drilling for hydrologic, environmental, petroleum and geothermal projects, but there had been no significant effort to compile information on low-temperature geothermal resources.

While there has been a substantial increase in direct-heat utilization during the last decade, the large resource base is greatly under-utilized. Since the thermal energy extracted from these resources must be used near the reservoir, collocation of the resource and the user is required. Development of a user facility at the site of the hydrothermal resource is often economically feasible. To expand utilization of the direct-heat resource, a current inventory of these resources is needed by potential users, together with the information necessary to evaluate the reservoirs and the economics of potential uses. To stimulate the development of an industry, it is necessary to reduce risks of development and this can be done by providing resource data and by cost-sharing of exploration and demonstration projects.

Direct-Heat Applications

Direct-heat use is one of the oldest, most versatile and the most common form of utilization of geothermal energy. Space and district heating, industrial applications such as food processing, greenhouse heating, aquaculture, etc.; and resorts/spas are the best known and most widespread forms of utilization. Table 1 gives the relative annual energy use in 1995 for each direct-heat application, and Figure 2 illustrates the growth rate of the direct-use industry since 1975.

Space- and district-heating projects have had the greatest progress and development of direct-heat utilization in the United States, where the total capacity of operating geothermal district- and space-heating systems is over 169 MWt. Geothermal district-heating systems (18), currently operating in cities in California, Idaho, New Mexico, Nevada, Oregon and South Dakota, save customers 30 to 50% in heating bills compared to conventional fuels. District-heating systems and heating of homes, schools, businesses, etc., have been on-going for 100 years or more with no diminishing of temperature or flow rates. Space heating systems which employ one well to heat a commercial building, school building or residence occur at 104 sites in 16 states. The design of most geothermal district-heating systems can be divided into five or six subsystems. These subsystems include: production facilities, central plants (closed-distribution systems only), distribution, customer connections, metering and disposal. It is the production facilities and disposal subsystems that tend to set geothermal systems apart from district heating in general.

Table 1. Annual Energy Supplied for Major Direct Heat Applications

<u>Application</u>	<u>Number Sites</u>	<u>States^a</u>	<u>Temperature Range (°C)</u>	<u>Capacity (MWt)</u>	<u>Annual Energy (TJ/yr)^b</u>
Space & District Heating	122	16	26 to 166	169	1,387
Industrial (food processing, gold mining, etc.)	12	6	86 to 154	43	632
Greenhouses	38	8	37 to 110	81	709
Aquaculture	27	9	16 to 93	64	1,359
Resorts & Spas	190	14	24 to 93	<u>71</u>	<u>1,605</u>
Total				428	5,692

a. Number of states where sites are located.

b. TJ = 10¹²J

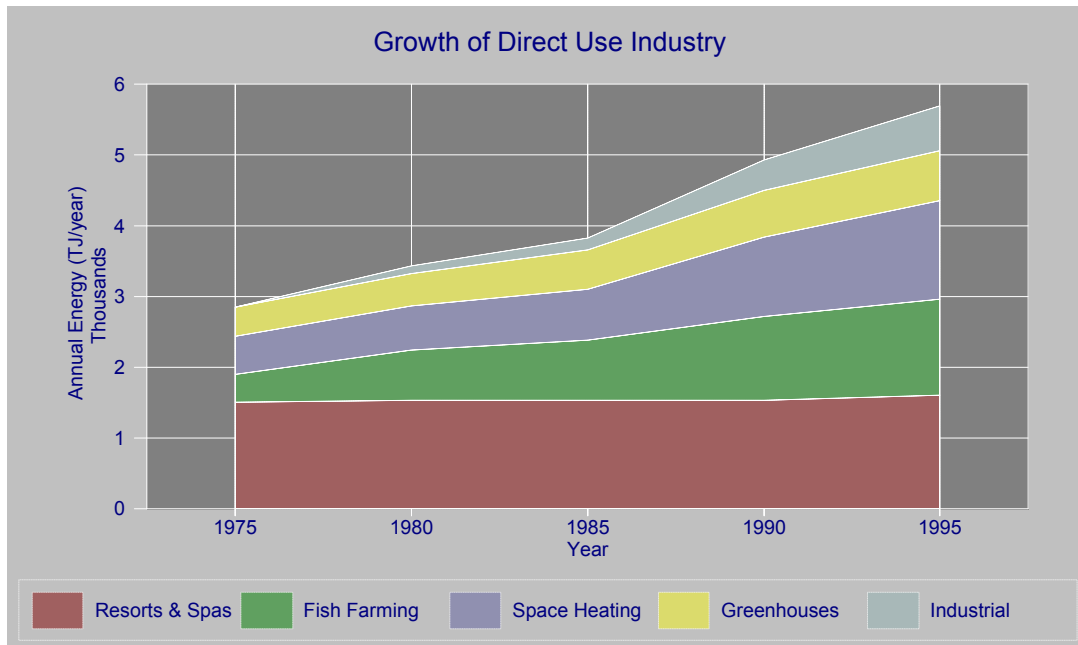

Figure 2. Growth of the U.S. geothermal direct-heat industry.

Since all current geothermal district systems operate in conjunction with low-temperature resources producing hot water rather than steam, hot water is the heat transfer medium in all cases. The geothermal fluid is generally pumped from the system's production well(s). Depending upon the design of the distribution system, the fluid is delivered to a central heat exchange plant (closed distribution) or directly to the customer through an "open" type of distribution network. Most current systems employ the open (no central heat-exchange plant) design. Under this approach, heat exchange takes place at the individual customers' connections. A typical open-type system appears in Figure 3. Figure 4 illustrates the closed-system design.

Disposal can be a significant part of the design of a geothermal system. Large quantities of fluid must be disposed of to accommodate system operation. Two approaches to this disposal are currently in use: surface disposal and injection wells. Most systems employ the less expensive surface disposal. Regulatory pressure and increasing development, however, suggest the likelihood of injection playing a larger role in the future.

Industrial applications using geothermal energy in the U.S. include: gold mining, food processing, grain drying, mushroom culture, sludge digester heating, greenhouse heating and aquaculture. The estimated geothermal energy use for industry in the U.S. to date is 188 MWt at 77 sites.

Geothermal food dryers, such as the vegetable dehydration plant at Brady, Nevada, can utilize sites with resource temperatures greater than 105°C for drying fruits and vegetables. There are many sites in this temperature range near agriculture production areas in western states. A new dehydration plant near Empire, Nevada began drying onions and garlic in January 1994.

The newest industrial use is to increase the efficiency of heap leaching for gold and other metals in Nevada. Geothermal energy provides more efficient leaching because of higher temperature and lengthening the period during which outdoor leaching may be done. The gold and other metals were originally deposited by geothermal water--epithermal deposits--and in some cases, geothermal heat is still available to extract them. Currently two sites are using geothermal energy and at least 10 other applicable sites have been located in Nevada. Similar geologic conditions occur in other states.

Greenhouses can utilize geothermal temperatures as low as 40°C. There are 38 geothermal greenhouse developments in 8 states. The largest is in New Mexico where over 30 acres have been developed at one site. There are many geothermal sites with fluid temperatures greater than 40°C in the 10 western states where potential developments could occur. Most growers agree that despite the cost of wells, pumping, and the higher cost of heating equipment, geothermal saves about 5-8% of heating costs. While this adds to the profit margin, the main reasons for moving all or part of their operation from an urban location to a rural geothermal area include clean air with more sunlight, fewer disease problems, clean fresh water, more stable work force, and in some cases, lower taxes.

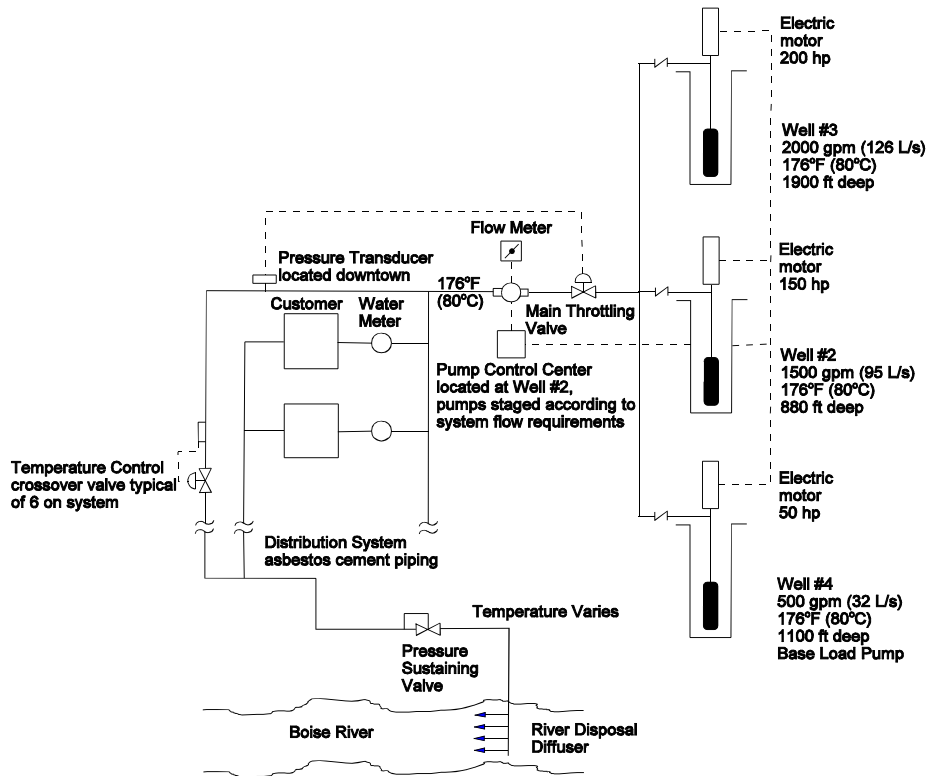

Figure 3. Geothermal district heating system - open distribution.

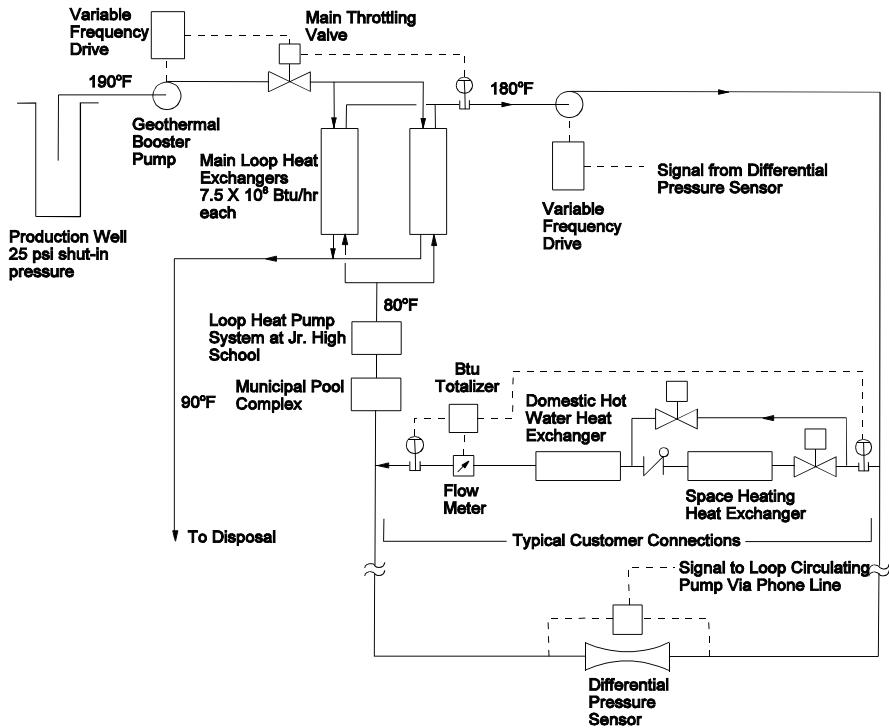

Figure 4. Geothermal district heating system - closed distribution.

Aquaculture is one of the fastest growing industries. Catfish processing increased 21% last year. Although only a small part of that increase involves geothermal facilities, it is well known that growth rates and food conversion are greatly enhanced with geothermal aquaculture. Geothermal aquaculture projects have obtained 50 to 300 percent growth-rate increases in aquatic species as compared to solar-heated ponds. Aquaculture can utilize geothermal resource temperatures as low as 21° to 27°C and can be cascaded from other uses. Geothermal aquaculture developments are currently operating at 27 sites (64 MWt), mainly in Arizona, and their number continues to increase.

Resorts and spas are the earliest use of low-temperature geothermal resources in the United States. Natural springs, especially geothermal springs, have gone through three stages of development: (1) use by Indians as a sacred place, (2) development by the early European settlers to emulate the spas of Europe and (3) finally, as a place of relaxation and fitness. In recent years, the main reason people in the U.S. go to geothermal spas are to improve their health and appearance, and to get away from stresses and to refresh and revitalize their body and mind. The use of mineral and geothermal waters has developed along three lines in this country: (1) the more plush hot springs resorts with hotel-type services and accommodations, (2) commercial plunges or spring pools and soaking tubs with perhaps a snack bar or camping facilities, and (3) the primitive undeveloped springs without any services. There are over 190 major geothermal spas in the USA and many more smaller ones along with thousands of hot springs (1,800 reported by NOAA in 1980).

Previous Compilation of Data on Hydrothermal Resources

The statewide databases of low-temperature geothermal resources in western states has not been updated for over a decade. In the early 1980s, data was compiled by state geological surveys and universities resulting in geothermal resource maps produced by the National Geophysical Data Center, National Oceanic and Atmospheric Administration (NOAA), for the Geothermal and Hydropower Technologies Division of the United States Department of Energy. The maps depicted low-temperature resource locations including thermal wells and springs. Some of the states presented water chemistry data coded on the map as well as water chemistry tables presented in accompanying text. The data developed at that time were readily shared between the U.S. Geological Survey (USGS) and the states on (Bliss and Rapport, 1983) a main-frame computer database of geothermal information. The GEOTHERM file was abandoned in 1983. Many of the technical maps of geothermal resources and accompanying data are out-of-print. Access to the original compiled geothermal data and water chemistry data became difficult. The new Low-Temperature Resource Assessment Program has provided a major update and ready access to the low-temperature geothermal database.

Descriptive Data and Fluid Chemistry

The state databases are designed for use on personal computers and have the capability of being accessed and managed using readily available commercial spreadsheets or data management software. The databases are available as Open-File Reports both in text form and on diskettes from the State Teams listed as references at the end of this report. The general format of the database was developed at a meeting of the State Team Principal Investigators in Salt Lake City, July 8, 1993. The format includes two general divisions: descriptive information and fluid chemistry. The field names, general description of their contents, and units are given in Table 2.

New fluid samples were collected from selected thermal springs and wells, which were not adequately represented by existing data, and each state submitted up to 10 samples for chemical analyses by ESRI as part of the study. Entries for geochemical analyses included a charge balance column as an indicator of analytical quality. Because geothermometers may be so variable, and require geologic input for accurate interpretation, calculated geothermometer were not included in the database tables. State Team P.I.'s were encouraged to report geothermometer results for selected (priority) resources in a separate table, keyed to other data by sample I.D. Appropriate discussion on geothermometers was included in some of the State Team final reports.

Database users can select a great variety of search and sort parameters using standard personal computer database management software to choose those records of interest from the database. Plot files to produce computer-generated maps of selected data were made utilizing the latitude and longitude coordinates in the database.

Table 2. State Geothermal Database, Data Field Summary

<u>Field Name</u>	<u>Field Contents</u>	<u>Units</u>
----- Descriptive Data -----		
Record ID	record ID number	NA
Source Name	owner or well/spring name	NA
County	county name or code	NA
Area	community of local region where located	NA
Location	well and spring numbering	cadastral coords.
Latitude	latitude north	decimal degrees
Longitude	longitude west	decimal degrees
Type	well (W) or spring (S)	NA
Temp	measured temperature	°C
Depth	depth of well	m
Flow	flow rate	L/min
Level	depth to water level	m
Status	operating status: pumped, flowing, etc.	NA
Use	use of the resource: space heating, green-houses, aquaculture, industrial, etc.	NA
Date	date of data	NA
Reference	short citation for source of data	NA
----- Fluid Chemistry Data -----		
Date	date sample was taken	mm/dd/yy
pH	pH of fluid	pH units
Conduct	Conductance	microseimens
Na	sodium	mg/L
K	potassium	mg/L
Ca	calcium	mg/L
Mg	magnesium	mg/L
Al	aluminum	mg/L
Fe	iron	mg/L
SiO ₂	silica	mg/L
B	boron	mg/L
Li	lithium	mg/L
HCO ₃	bicarbonate	mg/L
SO ₄	sulfate	mg/L
Cl	chloride	mg/L
F	fluoride	mg/L
As	arsenic	mg/L
TDS _m	total dissolved solids measured	mg/L
TDS _c	total dissolved solids calculated	mg/L
ChgBal	charge balance	(cations/anions)x100

STATE RESOURCE EVALUATION, INVENTORY AND RECOMMENDATIONS

State geothermal resource teams (State Team principal investigators' addresses in Appendix C) initiated their resource evaluation and data-base compilation efforts in late 1992 and early 1993, and completed these inventories and reports in 1994 and early 1995. The State Teams reviewed essentially all available sources of information on water wells and geothermal literature to arrive at the new inventory. The most productive sources of information included the USGS's on-line water information system known as the National Water Data Storage and Retrieval System, or WATSTORE, the 1983 USGS database file GEOTHERM, and previous state geothermal resource maps. State agency files of water-well records submitted by drillers were key data sources for some states, as were open-file and published reports by state agencies. With very few exceptions, the databases do not include drill holes used only as temperature gradient or heat flow sites. The data were checked for accuracy of site location, to the extent practical, and numerous corrections were made to previously published locations. Water analytical data were checked by evaluation of ionic charge balance.

Table 3 summarizes the catalog of 8,977 thermal wells and springs for these 10 western states; an increase of 82% compared to the previous assessment of 1980 to 1983. Each data entry in the inventory is a separate thermal well or spring (w/s). For purposes of this inventory and report, State Team P.I.s have often selected a single well or spring to represent several (2 to 20) wells or springs in a small area (generally $<1 \text{ km}^2$) within the same geothermal resource. Thus, the true number of thermal wells and springs represented by this inventory is substantially greater than the numbers reported here.

To improve reporting, the State Teams were asked to identify the number of distinct hydro-thermal resource areas represented by the wells and springs in the inventory. A distinct resource area may be less than 1 km^2 in areal extent, in the case of a few wells or springs in a small, fault-controlled resource, or more than 100 km^2 in the case of extensive thermal aquifers such as in the Snake River Plain or Columbia Plateau. More than 900 low- to moderate-temperature resource areas are indicated, and perhaps a greater number of isolated (singular) thermal wells or springs.

The State Teams and OIT Geo-Heat Center have documented direct-heat use of geothermal fluids at nearly 360 sites, including space and district heating, industrial applications and resorts/spas. Forty-eight high-priority resource study areas have been identified, together with high potential for near-term direct-heat utilization at 150 new sites. Identification of collocated communities and resources indicate that 271 cities in 10 western state could potentially utilize geothermal energy for district heating and other applications. The number of commercial and residential direct-heat users and the total energy use have increased dramatically in one decade. Even greater resource utilization would be expected without the competition of low-priced natural gas. With proper conservation and utilization of our geothermal resources, they will better to serve us when natural gas and other fuel types are less competitive. Several problem areas have been identified however, where the heat or fluid content of these resources are largely wasted and additional monitoring, reservoir management, and possibly regulation is warranted.

Table 3. State Geothermal Database Summary: 1992-95 Low-Temperature Program

	State PGA	AZ 1982	CA 1980	CO 1980	ID 1980	MT 1981	NV 1983	NM 1980	OR 1982	UT 1980	WA 1981
1. Thermal Well/ Springs	1995 PGA	1,251 501	989 635	157 125	1,537 899	267 68	457 796	359 312	2,193 912	792 315	975 368
2. Moderate Temp. Wells/Springs (100°C<T<150°C)	1995 PGA	0 0	32 48	0 0	20 0	0 0	16 35	10 3	88 79	3 3	1 1
3. Low Temp. Wells/Springs (20°C<T<100°C)	1995 PGA	1,251 501	957 587	157 125	1,517 899	267 58	441 761	349 309	2,105 925	789 312	974 367
4. Low Temp. Resource Areas (20°C<T<150°C)	1995 PGA	35 29	58 56	93 56	54 28	33 15	300 300	30 24	200 151	161 64	17 10
5. Space and District Heating Sites	1995	2	23	16	16	9	11	2	44	2	-
6. Industrial Appl. Sites (Dehydration, Greenhouses, Aquaculture, etc.)	1995	4	15	6	17	4	9	5	6	7	-
7. Resort/Spa Sites	1995	4	55	18	17	15	15	6	17	9	5
8. Areas, Collocated Communities	1995	14	70	15	51	18	30	12	32	23	6
9. Areas, High- Priority Resource Study	1995	3	7	6	5	4	4	4	5	4	6

Comments: PGA - Previous Geothermal Assessment. Tres = Estimated reservoir temperature.
The minimum low-temperature criteria is typically 20°C, but varies with climate.

The final reports, maps, and databases generated by the State Teams document the present knowledge of the resource base and its utilization and potential in some detail. A state-by-state summary of this information, and recommendations for high priority resource studies follows.

Arizona

Witcher (1995a) in completing the new resource inventory for Arizona, notes that almost all wells and springs found in Arizona at elevations below 5,000 feet (1,524 m) exceed 20°C. Accordingly, the new database is restricted to wells and springs with discharge temperature greater than 30°C, except for a few sites at higher elevations and sites on the Colorado Plateau of northern Arizona. Sites based only on bottom-hole temperature and temperature gradient or

heat flow measurements are also excluded. Even so, this new geothermal database totals 1,251 discrete thermal wells or springs, 250 percent of the 1982 listings. The database also includes 2,650 chemical analyses for these 1,251 sites.

Low-temperature resources occur in all counties of Arizona, but many fewer in the Colorado Plateau of northwest and north-central Arizona and the Transition Zone in Yavapai and Gila Counties in central Arizona. Witcher (1995a) notes that most thermal well occurrences are located along the trend of lower heat flow, where many irrigation wells tap deep-seated aquifers that are overlain by thermally-insulating, low-thermal conductivity sediments in highly-developed agricultural areas. These resources occur in the Mohave, Sonoran Desert, and Mexican Highland Sections of the Southern Basin and Range Province (SBRP).

Witcher (1995a) describes occurrence models for both convective and conductive resources in Arizona. He notes that in southeast Arizona and neighboring New Mexico, nearly all convective systems occur where aquitards or confining units have been stripped by faulting or erosion from basement terranes which contain significant vertical fracture permeability, which he terms a "hydrogeologic window model."

Conductive resources occur in the SBRP where grabens and half-grabens may contain several thousand feet (>1,000 m) of Cenozoic sediments with low thermal conductivity and low vertical permeability. The potential of large-volume conductive resources is offset by the cost of deep wells. In the eastern Colorado Plateau, several areas of high heat flow are collocated with significant thickness of fine-grained Cenozoic and Mesozoic sediments and are preserved over older, permeable aquifers. The fine-grained sequences act as aquitards and thermal blankets to create deep-seated conductive geothermal resources. The thermal fluids are often of high salinity, with few geological alternatives for fluid injection (Witcher, 1995a). The relatively low median temperature of about 36.6°C for all 1,251 sites is attributed to the predominance of conductive resources.

Witcher (1995a) provides considerable realistic insight regarding the future utilization of geothermal resources in Arizona. He notes that basins with most of the thermal (>30°C) wells have warm climates and space cooling is more needed than space heating. He notes that in Arizona the thermal fluids are more valued for irrigation of field crops, municipal water supply and industrial uses than for the heat carried by the waters. He sees some potential for space heating and district heating, but much more potential for direct-use application in the agricultural sector. Geothermal aquaculture is the only major direct-use application which has experienced noticeable growth in recent years. Arizona leads the nation in the use of geothermal fluids for aquaculture.

Rather than identify specific sites for detailed study to advance geothermal utilization in Arizona, Witcher offers several recommendations. A strong, in-state advocate for direct-use geothermal applications is needed. Key parameters for successful aquaculture and greenhousing, specific to Arizona, need to be determined, and detailed feasibility studies completed for these uses.

California

The new California low-temperature database lists 989 thermal wells and springs, an increase of 354 over the 635 data entries reported in 1980. In many areas, one or a few wells have been selected to represent many thermal wells drilled to similar depths in a thermal aquifer. The database includes only a few representative high-temperature (>150°C) wells, especially from KGRAs. Youngs (1994) estimates that there may be 58 distinct low-temperature resource areas, and an additional 194 "singular" thermal occurrences.

Low-temperature resources occur in volcanic terranes in northern California, in the Basin and Range Province in the northeastern part of the state, within the Long Valley caldera, and along faults in the sedimentary basins in southern California. Low- to intermediate-temperature resources often occur as outflow areas peripheral to the state's many high-temperature resources.

The commercial application of low-temperature geothermal fluids is already well developed in California with a large district heating system in the city of San Bernardino, and smaller projects in several other communities. Geothermal greenhouse and aquaculture industries have expanded substantially in the last decade, and at least 48 commercial resort/spa facilities utilize geothermal fluids.

Youngs (1994) has identified 56 communities that are located within 8 kilometers of a geothermal resource that has a reported temperature of at least 50°C. The total population collocated with these resources exceeds 2 million people. Thus, the potential for expanded use of these fluids in the near term is great, and this new low-temperature inventory is an important step in expanded use. Additional technical and feasibility studies will be required to prove the economic use of these fluids.

Youngs (1994) recommends seven areas for comprehensive resource studies, based in part on population considerations. The Coachella Valley (Riverside County) is a major agricultural area with a population around 200,000. A number of thermal wells and springs occur along a 20 - 30 km extent along the west side of the valley; but, there is no comprehensive study of the resource. Potential applications may include aquaculture and food drying.

In Alturas (Modoc County), the geothermal resource provides space heating for the local high school. The city would benefit from a comprehensive resource study which could provide the basis for expanding the space heating to other structures in the community. At Lake Elsinore, Riverside County, thermal wells and springs with temperatures to 54°C could provide space heating to community buildings. A detailed resource assessment study is recommended (Youngs, 1994).

Comprehensive resource assessments are recommended for geothermal resources collocated with Ojai, Ventura County; Lake Isabella, Kern County; and Hemet/Winchester, Riverside County. Each resource has measured temperatures greater than 50°C, but little or no resource utilization.

The Huntington Beach/Los Angeles Basin, Orange and Los Angeles Counties, is located in part over major oil fields that produce thermal waters as a waste product of petroleum production. There are at least 12 petroleum fields with very large quantities of associated thermal water, as characterized by the Venice Field of 21 million Btu/hr at 82°C. There is great local interest in utilizing the geothermal resource. Technical and feasibility studies may speed the beneficial use of this resource.

Colorado

The new database for Colorado includes 157 wells and springs compared to the 125 reported in the 1980 assessment. Cappa (1995) identifies 93 geothermal areas each generally less than 8 km² in size, up from the 56 areas reported in 1980. A total of 382 geochemical analyses was compiled. The great majority of geothermal areas occurs west of the Front Range within the Rocky Mountain Province. A grouping of seven areas occurs west of Trinidad in the south-central part of the state. The measured temperatures for most areas fall in the 25 to 40°C range; but, fluid temperatures exceed 50°C at 15 geothermal areas, with a maximum temperature of 85°C at Mt. Princeton Springs in Chaffee County. Here subsurface reservoir temperatures of 150 to 200°C are indicated by a variety of geothermometers (Cappa, 1995).

The present level of direct-heat utilization in Colorado is substantial, totaling 32 sites. District heating systems are in service at Pagosa Springs and Ouray, and space heating is utilized at 15 additional motels, lodges, and resorts (Lienau, et al., 1994). Two greenhouses utilize thermal fluids for heating, and aquaculture uses fluids at four additional sites. Spas and bathing spring resorts occur throughout western Colorado, and are a major part of the economy of communities such as Glenwood Springs, Pagosa Springs, Idaho Springs, Steamboat Springs, Mount Princeton, Durango, Gunnison, and Ouray.

Cappa (1995) identified six geothermal resource areas collocated with, or near, population centers which are on the fringe of geothermal development. The areas are:

1. Archuleta Antiform, Archuleta County
2. Eastern San Luis Valley, Saguache and Alamosa Counties
3. Rico and Dunton Hot Springs, Dolores County
4. Trimble Hot Springs, La Plata County
5. Orvis Hot Springs, Ouray County
6. Cottonwood Hot Springs, Chaffee County

The indicated reservoir temperatures range from 40°C to as much as 200°C (Cottonwood Hot Springs). Potential utilization of these resources include most common direct-heat uses.

A variety of R&D activities are recommended to further the development of these resources. These include the compilation of oil and water well data; geological and geophysical studies; thermal gradient drilling; water sampling and fluid geochemistry.

Four other areas with promising hydrothermal resources, far from a population center were also identified:

1. Deganahl well, Routt County
2. Brands Ranch well, Jackson County
3. Craig warm water well, Moffatt County
4. Hartsel Hot Springs, Park County.

Idaho

Extensive drilling in Idaho since the pervious geothermal assessment (Mitchell, et al., 1980) has resulted in a large increase in the known thermal-water occurrences. Dansart, et al., (1994) have compiled a database of 1554 entries for 1537 individual wells and springs, compared to the 899 wells/springs of the earlier compilation. A bibliography of over 750 references on Idaho thermal water accompanies the report. Dansart, et al., (1994) describe 54 resource areas, some of which may overlap, compared to 28 recognized areas identified previously. Many isolated thermal wells and springs occur throughout the state.

Geothermal resource areas occur throughout the state of Idaho, except the northernmost panhandle of the state. The geologic setting of the hydrothermal occurrences varies greatly, including fault and fracture-controlled resources of the Idaho batholith; fault-controlled reservoirs of the northern Basin and Range Province; the Island Park-Yellowstone caldera complex; and the extensive volcanic reservoirs of the Snake River Plain. The state's largest thermal reservoir area,

Bruneau-Grand View, includes an area of perhaps 2850 km² (Dansart, et al., 1994). Measured temperatures range as high as 149°C at Raft River, and geothermometers suggest some reservoir temperatures of 200°C. Clearly the geothermal potential of Idaho is very large, and it is greatly under-utilized.

Lienau, et al., (1994) report five district heating systems in Idaho. The Boise system, which is the nation's oldest, has been operating since the 1890s. Ten other sites utilize space heating and 17 sites use thermal fluids for aquaculture or greenhouses. Thermal resorts and pools number 27.

Dansart, et al., (1994) recommend site specific studies for nine geothermal resource areas, the highest priority for study being the Twin Falls area. A large geothermal reservoir is collocated with the population center of Twin Falls and development of the reservoir has resulted in a recent decline of water levels in several wells being used for space heating, including the geothermal space heating system of the College of Southern Idaho. Unfortunately, the artesian pressure of the geothermal system has been used to generate electricity for sale of power to power companies, without beneficial use of the heat or water resource. Additional studies are needed to develop conceptual and numerical models of the reservoir which may provide a basis for resource management decisions. Similar studies and arguments apply to the Boise area geothermal resource.

Geologic, geophysical, drilling and feasibility studies are proposed for several other resource areas with good potential for beneficial space heating, greenhousing, aquaculture, and possibly electric power development. Other high-priority areas identified by Dansart, et., al., (1994) are: Pocatello-Tyheee and Lava Hot Springs (Bannock County); the Garden Valley area (Boise County); Camas Prairie area (Camas County); Nampa-Caldwell area (Canyon County); Greys Lake and Blackfoot Reservoir area (Caribou County); Island Park area (Fremont County); and Big Creek Hot Springs (Lemhi County). Idaho clearly has extensive geothermal resources collocated with population centers, and utilization of these resources may be quite economic at this time.

Montana

The 1994 Montana geothermal database includes 291 records from 267 distinct wells and springs (Metesh, 1994). For this northern state, a minimum observed temperature of 10°C above the mean annual air temperature (as low as 3°C) or 13°C could qualify as a thermal site. This is somewhat fewer than the 346 sites reported by Sonderegger, et al., (1981) and reflects a strict elimination of "warm-day" sampling or improper purging of shallow well samples. Sixteen resource areas and more than 100 isolated thermal occurrences are indicated.

Thermal wells and springs occur throughout all areas of Montana but mainly (152 of 267) in the western third of the state (the Northern Rocky Mountains). The plains of the eastern two-thirds of the state host 115 of the 267 thermal sites (Metesh, 1994). About 77 percent of the geothermal sites have measured water temperatures less than 40°C, but 12 percent have temperatures greater than 50°C. Geothermometer temperatures calculated for more than 50 records with acceptable chemistry indicate several reservoir temperatures above 100°C. New fluid sampling and geothermometer results indicate reservoir temperatures of about 107°C at Green Springs, 120°C at Hot Springs Area, and 130°C at Boulder Hot Springs.

Geothermal resources are not fully utilized in Montana, due in part to the limited and scattered population. Lienau, et al., (1994) document space heating at nine sites and limited greenhouse, aquaculture, and industrial utilization. Perhaps 15 resorts and spas make use of the thermal fluids. Metesh (1994) has identified five geothermal resource areas collocated with communities which have good potential for resource utilization, and these are recommended as priority study areas.

The Bozeman area has experienced steady population growth over the last decade. Bozeman Hot Springs, just west of the city of Bozeman, has surface temperatures of approximately 55°C and estimated reservoir temperatures of 80°C. Geophysical exploration and deep drilling are needed to better define the source and extent of the resource area. Detailed temperature, fluid chemistry and feasibility studies are needed to evaluate potential utilization of the low-temperature thermal waters (to 33°C) in the Butte area. The geothermal resource near Ennis (Madison County) is relatively well studied, but deep drilling and a feasibility study are needed to evaluate use of this >80°C resource. Boulder Hot Springs, with an estimated reservoir temperature of 110 - 130°C, is well located for space heating, but requires additional resource studies. The Camas Prairie area, Sanders County, includes a number of thermal wells and springs, with reservoir temperatures of 50 - 80°C. Metesh (1994) suggests that additional studies in this area may accelerate the use of thermal waters for local recreation facilities and cottage industries.

Nevada

Nevada is well endowed with both high- and low-temperature geothermal resources. The latter are distributed rather uniformly throughout the entire state. Garside (1994) made a careful selection of 457 thermal spring/well entries from a much larger (>2,000) candidate list to represent the geothermal resources of Nevada. He notes that the mean annual air temperature varies from less than 7°C in northern parts of the state to over 18°C in the south, varying as a function of latitude and elevation. Seven high-temperature (>150°C) wells were included to represent thermal areas which also included lower-temperature (but poorly documented) resources. Perhaps 90 percent of the state has potential for the discovery of low- to moderate-temperature resources. Garside (1994) believes the more than 1,000 thermal springs and wells represent several hundred resources areas.

Essentially all of Nevada lies within the Basin and Range Province, an area of crustal extension which has remained geologically active since the mid-Miocene. The thermal waters of most higher-temperature and many lower-temperature resources are believed to derive their heat from deep circulation of groundwater along faults in an area of higher-than-average heat flow. In east-central and southern Nevada, the low- to moderate-temperature resources may be related to regional groundwater circulation in fractured carbonate-rock aquifers (Garside, 1994).

In Nevada, as in many arid areas of the west, most water (whether thermal or non-thermal) has been put to use, and thermal waters may be cooled before use (Garside, 1994). Direct heat applications include district heating systems at Moana Hot Springs (in the southwestern part of Reno) and Elko; swimming pool and resort use; vegetable drying and aquaculture. There is great potential for expanded direct use of thermal fluids where communities or users are collocated with resource.

Many remotely located hydrothermal resource areas are not represented by the present inventory, but have been noted by private companies engaged in mineral and geothermal exploration. One priority recommendation for future studies is an attempt to access these data and thus improve the present database. Several communities collocated with geothermal resources have good potential for space heating, district heating, and industrial heating. These areas are: Hawthorne area, Mineral County; Fallon Naval Air Station, Churchill County; East Elko, Elko County; Caliente, Lincoln County; and South Truckee Meadows, Washoe County. Recommended studies to expedite geothermal utilization include data compilation, geological and geophysical surveys, water chemistry, and feasibility studies.

New Mexico

The updated New Mexico resource inventory (Witcher, 1995b) includes 359 discrete thermal wells and springs compared to the 312 wells/springs reported by Swanberg (1980). This increase is more significant in view of the fact that all the sites of deep wells with bottom-hole temperatures (BHT) included in the 1980 listing have been deleted, and that only sites with temperatures greater than 30°C are included for wells and springs below 1524 m (5000 ft) elevation. The database includes 842 chemical analyses for the 360 discrete wells and springs. A median temperature for 308 sites (excluding the high-temperature wells and springs of the Jemez Mountains) is about 35°C. At least 29 different resource areas and perhaps 151 isolated thermal occurrences have been identified.

Almost all of the thermal sites occur in the western half of the state, within the Colorado Plateau, Basin and Range, and Rocky Mountains physiographic provinces (Witcher, 1995b). Virtually all of the convective geothermal systems in New Mexico, including the Jemez systems, occur over Laramide structural highs (Witcher, 1995b). Witcher (1995b) believes that virtually all New Mexico convective occurrences occur where aquitards or confining units have been stripped by faulting or erosion from basement terranes which contain significant vertical fracture permeability--a model he refers to as a "hydrogeologic window model." Extensive conductive

geothermal resources are present in the Basin and Range Province, the Rio Grande Rift, and in the Colorado Plateau. Witcher notes that the cost of deep wells, and fluids with high salinity, are drawbacks to the utilization of many of these conductive resources.

New Mexico has had significant direct-use geothermal development since the early 1980s, with a large district heating system at New Mexico State University, and the largest total acreage of geothermal greenhouses (more than 40 acres--161,900 m²) in the nation. At present, there is considerable interest in the use of geothermal heat for greenhouse, aquaculture, crop and food processing, and milk and cheese processing. The new database will certainly aid further direct-use geothermal development.

Witcher (1995b) has identified eight resource areas with near-term utilization potential which need site-specific geologic and feasibility studies. The Rincon geothermal system, Dona Ana County, is well located to provide greenhouse heat, milk and cheese processing, chile processing, refrigerated warehousing and possibly electrical power using binary technology. Detailed geologic mapping, drilling of a shallow production hole, and reservoir testing would speed the development of this promising resource. A phase 1 exploration program to define a resource north and west of Truth or Consequences could encourage local support for space heating, district heating, geothermal greenhouse and aquaculture. An updated feasibility study for the Las Cruces East Mesa resource may encourage substantial additional use of this large resource which is collocated with one of the fastest growing medium-sized cities in the United States. Hydrogeologic studies are needed to support the extensive greenhouse developments at Radium Springs and Lightning Dock.

Oregon

The Oregon Department of Geology and Mineral Industries (DOGAMI) compiled a database of 2,193 thermal well/spring sites, an increase of 1,281 over the 1982 compilation (Black, 1994). These springs and wells may represent more than 200 resource areas. The study confirmed a conclusion from the earlier assessment (NOAA, 1982) that the entire state east of the Cascade Range, except for the crest of the Willowa Mountains, was "favorable for the discovery at shallow depth (less than 1,000 m) of thermal water of sufficient temperature for direct heat applications." It appears that the entire Columbia Plateau Province may be underlain by large volumes of 20° - 25°C water at relatively shallow depth.

Thermal fluids of 89° - 99°C are used for a district heating system by the city of Klamath Falls (Lienau, et al., 1994). Other uses include space heating at a number of sites, greenhouse heating, aquaculture, and resorts and pools. Most of the state may be suitable for geothermal heat pump applications (Lienau, et al., 1994).

Five areas have been recommended for high priority studies to support near-term utilization of the fluids. The Paisley area, Lake County, has an estimated reservoir temperature of 112°C, and may be appropriate for binary electric-power generation, greenhouses, or industrial

process heat (lumber drying). An earlier feasibility study for lumber drying needs to be updated, and reservoir studies would assist the evaluation of electric power-generation possibilities. The Lakeview system in Lake County may be appropriate for space heating and greenhouses. Geophysical studies to define faults and a district-heating feasibility study are high-priority recommendations.

Feasibility studies are recommended to assess the economics of space heating, greenhouse heating and aquaculture projects at three other areas: Burns/Hines, Harney County; LaGrande/Hot Lake, Union County; and Vale, Malheur County.

Utah

Blackett (1994) lists 964 entries for 792 thermal wells and springs in the new Utah database. This compares to only 315 thermal wells and springs documented in the 1980 compilation. Blackett (personal communication) estimates 161 different hydrothermal resource areas.

Utah comprises parts of three major physiographic provinces: the Colorado Plateaus, the Middle Rocky Mountains, and the Basin and Range. Hydrothermal resources with temperatures greater than 50°C occur in each province, and in the Transition Zone between the Basin and Range Province, and the Colorado Plateau Province in central Utah. Most of the higher-temperature resources occur in the Basin and Range Province, an area of active east-west extension, and young (<1 Ma) volcanic rocks, and high average heat flow (80 - 120 MW/m²). In central and western Utah, most thermal areas are located in valleys near the margins of mountain blocks, and are thought to be controlled by active Basin and Range faults. Others occur in hydrologic discharge zones at the bottom of valleys. The most significant known occurrence of thermal waters in the Colorado Plateau of eastern Utah is from wells of the Ashley Valley oil field, which yield large volumes of nearly fresh water at temperatures between 43 and 55°C (Blackett, 1994).

Regional low energy costs have contributed to the relatively low growth of geothermal energy in Utah. Presently, electric power is generated at two areas, the Roosevelt Hot Springs and Cove Fort-Sulphurdale KGRAs. Commercial greenhouses use thermal water for space heat at Newcastle in Iron County, and at Crystal Hot Springs in Salt Lake County. Ten resorts use thermal waters for swimming pools, spas and baths (Blackett, 1994).

Seven geothermal areas in Utah are recommended for additional studies when funding becomes available. These studies would aid in expanded use and better management of resources currently in production, and could encourage development of previously unused resources. The Newcastle area, where rapid development of the resource for a growing greenhouse industry is taking place, is perhaps the highest priority. In order to adequately protect the geothermal aquifer

and ensure a continued supply of energy to commercial users, geohydrologic studies and numerical modeling of fluid flow and heat transfer is needed. Slimhole drilling is also needed to evaluate the center of the geothermal system (Blackett, 1994).

The Midway geothermal system, with observed temperatures about 45°C and a probable reservoir temperature around 70°C, extends for several square kilometers around the community of Midway. Midway is a growing resort community located about 8 km from Heber City. Thermal water has been used for decades in pools and spas, and many new residences are using the waters for space heating. Drawdown of the resource has been observed, and water rights of established users may be compromised as development of the resource continues. Additional work is required to define the hydrologic controls of the system and to provide a technical basis for management of the thermal system. The Monroe Hot Springs - Red Hill Hot Springs resource in Sevier County provides thermal fluids for a small resort which, as a result of a change in ownership, may become a much larger destination resort. Hydrologic and space-heating feasibility studies should be completed to aid in managing the resource. Hydrologic studies are also needed to evaluate the Crystal Hot Springs area, in southern Salt Lake County. Here Utah Roses, a commercial greenhouse operator, produces thermal waters from wells for space heating.

Two other geothermal systems, Thermo Hot Springs and the Wood's Ranch geothermal area, are not located near major communities, but large agricultural areas occur to the east, north and south. Each area would benefit from a limited exploration program to determine resource potential (Blackett, 1994).

Washington

Schuster and Bloomquist (1994) have compiled a resource database which includes 1044 entries with 941 thermal (>20°C) wells; 34 thermal springs and fumaroles; and 238 chemical analyses. This compares with 368 thermal sites reported by Korosec, et al., (1981). The new database includes every qualifying water well (>20°C) but only a few oil and gas wells selected from other databases. Christie (1994) provides an extensive bibliography and index of geothermal literature for the state of Washington.

Schuster and Bloomquist (1994) make several interesting observations concerning the distribution of thermal sites in Washington. Most thermal springs occur in the Cascade Range, and many are associated with stratovolcanoes. In contrast, 97 percent of the thermal wells are located in the Columbia Basin of southeastern Washington, and 83.5 percent are located in a six-county area. Yakima County, with 259 thermal wells, has the most. Most of the thermal springs are associated with a stratovolcano or a fault, where the waters have circulated more deeply or in areas of higher geothermal gradients. The springs are much less dilute than the well waters, with major chemical species averaging a total of 1,570 ppm.

Thermal wells are strongly associated with the Columbia River Basalt Group and the Columbia Basin. The Columbia River Basalt Group is a thick succession of theolitic basalts that was erupted from fissures in southeastern Washington, northeastern Oregon and western Idaho between about 17 million and 6 million years ago (Schuster and Bloomquist, 1994). More than 300 lava flows occurred and interflow sediments are present between many pairs of flows. The Yakima fold belt developed during and after volcanism, and includes a series of sharply defined anticlines, faults and broad, flat synclinal basins. The flow tops and bottoms and interflow sediments are generally quite porous and permeable and make good aquifers. The Columbia Basin has a high regional temperature gradient at 41°C/km, and this accounts for most of the thermal wells, although many wells exhibit higher temperatures indicative of temperature gradients to 77°C/km. Thermal waters can be reached, in many cases, by wells only 65 m deep.

Schuster and Bloomquist (1994) discuss a number of legal and institutional problems which need to be resolved before utilization of the thermal waters becomes widespread. At least 250 of Washington's thermal wells are publicly-owned, and many of these are located near public buildings that might be economically heated through the use of geothermal water-source heat pumps. The waters are quite dilute, averaging only 260 ppm total for eight major chemical species.

Washington State investigators have identified laterally extensive low-temperature resources in a six-county area within the Columbia Basin. Rather than prioritize limited areas within this region for detailed studies, they make three recommendations for greatly expanding geothermal use in the state. The top recommendation is: to match existing thermal wells with proposed new construction or remodeling of public buildings; determine which projects could make advantageous use of geothermal resources; and then encourage and facilitate such applications.

A second recommendation is to station an investigator in the Columbia River Basin to find and visit new wells, measure temperature gradients, obtain well-test data and drill cuttings, and collect water samples for chemical analyses. A third recommendation is to inform state residents and policy makers about uses of geothermal energy, help policy makers form a legal and institutional framework which encourages wise use, and advocate the use of geothermal resources in place of fossil fuels.

COLLOCATED RESOURCES

An important part of the assessment was to complete a statewide collocation study of geothermal resources and communities in the western states in order to identify those communities and encourage them to formulate and implement geothermal resource development strategies. The population of these communities varied from less than 100 people to several hundred thousand. Historically, most of the communities that were identified have experienced some development of their geothermal resources. However, depending on the characteristics of the resource, the potential exists for increased geothermal development for applications such as space- and district heating, industrial, greenhouse and aquaculture operations, resort/spa facilities, and possible electrical power generation in some areas.

Allen (1980) inventoried eight western states to identify incorporated communities located within 8 km of a thermal well or spring having a temperature of 10°C or greater. Inventoried states included: Alaska, Arizona, California, Hawaii, Idaho, Nevada, Oregon, and Washington. The inventory identified a total of 1,277 geothermal sites within 8 km of 373 cities and towns, with a combined population of 6,720,347 persons. The combined heat load for all communities (exclusive of industrial loads) was estimated at 140,000 TJ/yr. This was the first known region-wide compilation of communities possessing geothermal potential for direct-use or heat pump potential.

In the present study, the ten State Team databases were searched for all the wells and springs with temperatures greater than or equal to 50°C (Boyd, 1995). From that list a Paradox database was compiled which contained 18 data fields. The information included within the data fields are the collocated community, latitude and longitude, resource temperature, number of wells within the area, typical depth, typical distance from the resource, total flow for all the resources within the area, typical use, weather data and economic development agency contacts in the area. Appendix A contains selected data fields for 271 collocated communities.

A collocated community was identified as being within 8 km (5 miles) of a geothermal resource with a temperature of at least 50°C. At least 1,900 thermal wells and springs were identified by the State Teams of having temperatures greater than or equal to 50°C. Of those 1,900 wells and springs, 1,469 were located within 8 km of a community. The communities for each state are shown on the state maps in Appendix B with quick reference for each site to typical resource temperatures (°C), typical well depth (m), flow (L/min) and total dissolved solids (mg/L).

GEOTHERMAL ENERGY COST EVALUATION

In order to assist potential users and developers of the high-priority and collocated sites identified in this report, software has been developed to quickly calculate the relative economic merit of geothermal energy as an energy source compared to natural gas (Rafferty, 1995). It is important to characterize these energy sources in terms of cost, both capital cost and unit energy cost. Geothermal energy costs vary with depth and character of the resource, number of production and injection wells, and many other parameters.

Using resource, financing and operating inputs, the spreadsheet calculates the capital cost for production well(s), well pump(s), wellhead equipment, injection well(s), and connecting pipelines. These capital costs are used along with the quantity of annual energy to be supplied and financing information to produce a unit cost of energy. Unit costs for operation (maintenance and electricity) are added to arrive at a total unit cost in \$ per million Btu for geothermal heat. To put this value into perspective, similar costs for an equivalent sized boiler plant are also calculated. These values can then be compared to determine the relative economic merit of geo-thermal energy for any specific set of circumstances. This information is particularly useful at the conceptual stage of a project when decisions as to fuel source are typically made by the developers. The spreadsheet (Figure 5) compares two basic approaches to producing heat: a geothermal system, and a gas boiler plant.

INPUT		OUTPUT	
Peak Load	20000000 Btu/hr	Required Flow	1000 gpm
Load Factor	0.3 decimal	CAPITAL COSTS	
Temperature Drop	40 F	Production Well	417726 \$
Electricity Cost	0.07 \$/kwh	Well pump	122371 \$
Electricity Cost	5 \$/kw	Wellhead Equip.	58678 \$
Interest Rate	0.08 decimal	Injection Well	0 \$
Loan Term	20 yrs	Pipe Line	25575 \$
No of Prod Wells	2	Total Geo Cost	624350 \$
Depth	2500 Ft	Boiler plant cost	116860 \$
Temperature	180 F	GEOTHERMAL UNIT	
Hard Drilling %	0.6 decimal	Unit Cap Cost	1.21 \$/MMbtu
Soft Drilling %	0.4 decimal	Unit Maint Cost	0.28 \$/MMbtu
Specific Capacity	5 gpm/ft	Unit Elec Cost	0.80 \$/MMbtu
Static Water Lvl	300 ft	Total Unit Cost	2.29 \$/MMbtu
Open hole?	1 Y=1,N=0	BOILER UNIT COSTS	
No of Prod Pumps	2	Boiler Fuel Cost	5.73 \$/MMbtu
No of VSD's	2	Equip Unit Cost	0.26 \$/MMbtu
No of Inj Wells	0	Maint Unit Cost	0.07 \$/MMbtu
Inj well eff	0.7 decimal	Total Unit Cost	6.06 \$/MMbtu
Depth	500 ft	Simple Payback	2.56 yrs
Static water lvl	100 ft		
Casing Depth	500 ft		
Boiler Efficiency	0.75 decimal		
Natural Gas Cost	0.43 \$/therm		

Figure 5. Spreadsheet for a geothermal system and gas boiler plant.

For the geothermal system, up to 3 production wells can be specified. Well casing is sized to accommodate a pump capable of supplying the required flow rate. Costs are included for drilling, casing, cementing, packers, bits and drill rig mobilization. An option is provided for open hole completion. Wells can be equipped with production pumps at the user's discretion. Pumps are assumed to be oil lubricated/lineshaft type and can be equipped with electronic variable-speed drives. The spreadsheet calculates the total pump head (including injection pressure if applicable), bowl size, number of stages, lateral requirements, column size and length, and all costs. Well head equipment includes piping, check valve and shut-off valve along with electrical connections and accessories for the motor. All of these items are assumed to be located in an enclosure.

Injection wells (up to 3) can be included in the system at the users discretion, along with a user defined casing depth. Cost components for the injection wells are similar to those described for the production wells; although, the drilling costs used for injection are higher than those used for production. This cost is 20% higher to allow for alternate drilling methods sometimes employed for injection wells.

Finally, piping connecting the production wells and injection wells to the building (or process) are included to complete the geothermal system. A 15% contingency is added to all major cost categories.

The boiler plant costs are calculated for a cast iron gas-fired boiler including: boiler and burner, concrete pad, breaching to flue, gas piping, combustion air louvers, expansion tank and air fitting, air separation, relief valve and piping, feed-water assembly, boiler room piping and shut-off valves. The spreadsheet is intended to compare geothermal to other conventional methods of supplying heat. As a result, it focuses upon the heat source only. Costs necessary for interface with a specific use, such as a heat exchanger, fan coil units or distribution system are not included.

As a general example of the use of the spreadsheet, consider a local economic development agency in an area of known geothermal resources. The economic development agency may wish to determine the relative economic merit of geothermal use for new industrial developments as a function of required well depth. Output from the spreadsheet can be used to develop the curve illustrated in Figure 6. This graph assumed a 3 MW_t load at two different load factors: 20% representing greenhouse or multi-building district heating, and 30% representing an industrial process load. The basis for the cost competitiveness graph is:

- Electric costs @ 0.07 \$/kWh and 0.05 \$/kW ;
- One production well/one injection well (where applicable);
- 20 year financing @ 8%;
- 60% hard drilling and 40% soft drilling;
- Open hole completion on production well;

- Lineshaft production well pumps;
- Full depth casing on injection wells; and
- Natural gas rate @ 0.43/therm and 75% efficiency.

Even for this relatively small load, conditions are favorable (simple payback less than 5 years) for geothermal heat for all applications up to a well depth of 750 m without injection. For higher load factor applications, a well depth of up to 600 m with injection provides a simple payback of less than 5 years. Figure 7 shows the effect of doubling the load to 6MWt (20,000,000 Btu/hr), which results in a significantly reduced payback period even when a second well must be added.

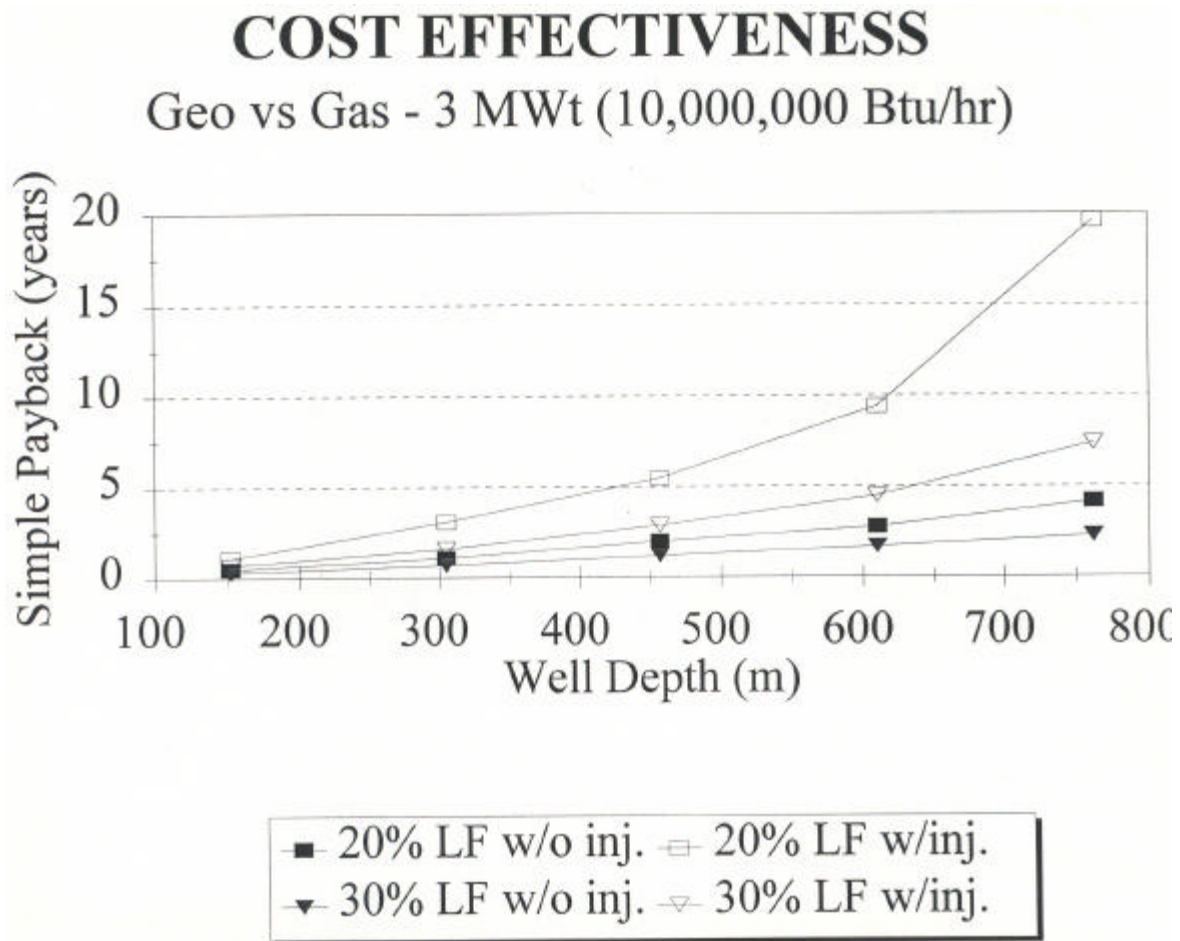

Figure 6. Cost effectiveness of geothermal energy vs. natural gas for a 3MWt (10,000,000 Btu/hr) load with one production well.

COST EFFECTIVENESS

Geo vs Gas - 6 MWt (20,000,000 Btu/hr)

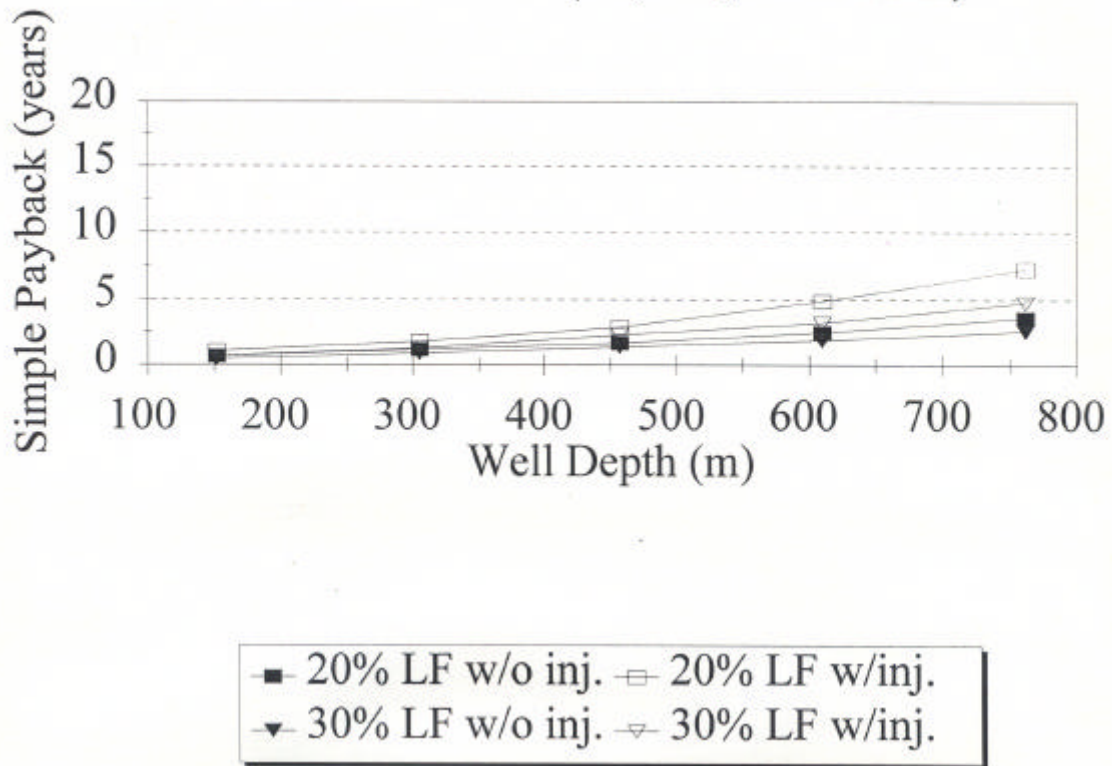

Figure 7. Cost effectiveness of geothermal energy vs. natural gas for a 6 MWt (20,000,000 Btu/hr) load with two production wells.

REFERENCES

- Allen, E., 1980. "Preliminary Inventory of Western U.S. Cities with Proximate Hydrothermal Potential", Vol. 1. Technical Report to the U.S. Department of Energy and Housing and Urban Development, 54 p.
- Bliss, J. D. and A. Rapport, 1983. GEOTHERM: The U. S. Geological Survey Geothermal Information System: Computers and Geosciences, v. 9, no. 1, p. 35-39.
- Black, G., 1994. "Low-Temperature Geothermal Database for Oregon", Oregon Department of Geology and Mineral Industries, Technical Report to Oregon Institute of Technology, Geo-Heat Center, 11p.
- Blackett, R. E., 1994. "Low-Temperature Geothermal Water in Utah: A Compilation of Data for Thermal Wells and Springs Through 1993", Utah Geological Survey Open File Report 311, 34 p.
- Boyd, T. L., 1995. "Collocated Resources", Geo-Heat Center Quarterly Bulletin, v. 16, no. 4, p. 15-22.
- Cappa, J. A. and H. T. Hemborg, 1995. "1992-1993 Low-Temperature Geothermal Assessment Program, Colorado", Colorado Geological Survey Open File Report 95-1, 19 p.
- Christie, R. A., 1994. "Bibliography and Index of Geothermal Resources and Development in Washington State, with Selected General Works", Washington Division of Geology and Earth Resources, Open File Report 94-1, 56 p.
- Dansart, W. J.; Kauffman, J. D. and L. L. Mink, 1994. "Overview of Geothermal Investigations in Idaho, 1980 to 1993", Idaho Water Resources Research Institute, University of Idaho, Research Technical Completion Report, 79 p.
- Garside, L. J., 1994. "Nevada Low-Temperature Geothermal Resource Assessment: 1994", Nevada Bureau of Mines and Geology, Mackay School of Mines, Final Technical Report to Oregon Institute of Technology, Geo-Heat Center, 18 p.
- Korosec, M. A.; Kaler, K. L.; Schuster, J. E.; Bloomquist, R. G.; Simpson, S. J. and D. D. Blackwell, 1981. "Geothermal Resources of Washington", Washington Division of Geology and Earth Resources, Geological Map GM-25, scale 1:500,000.
- Lienau, P.; Lund, J.; Rafferty, K. and G. Culver, 1994. "Reference Book on Geothermal Direct Use", Oregon Institute of Technology, Geo-Heat Center, Technical Report to USDOE Geothermal Division, 52 p.

Lienau, P. J.; Ross, H. P. and P. M. Wright, 1995. "Low-Temperature Resource Assessment Program", Proceedings, World Geothermal Congress, Florence, Italy, p. 645-648.

Metesh, J., 1994. "Geothermal Resources of Montana", Montana Bureau of Mines and Geology, Technical Report to Oregon Institute of Technology, Geo-Heat Center, 30 p.

Mitchell, J. C.; Johnson, L. L and J. E. Anderson, 1980. "Geothermal Investigations in Idaho: Potential for Direct Heat Application of Geothermal Resources", Idaho Department of Water Resources Water Information Bulletin 30, Part 9, 396 p.

Muffler, L. J. P., editor, 1979. "Assessment of Geothermal Resources of the United States - 1978" U. S. Geological Survey Circular 790, 163 p.

National Oceanic and Atmospheric Administration, 1982. "Geothermal Resources of Oregon.: Geothermal data compiled by Oregon Department of Geology and Mineral Industries, NOAA Map, scale 1:500,000.

Rafferty, K., 1995. "A spreadsheet for Geothermal Direct Use Cost Evaluation", Oregon Institute of Technology, Geo-Heat Center, Technical Report to USDOE Geothermal Division, p. 27.

Reed, M. J., editor, 1983. "Assessment of Low-Temperature Geothermal Resources of the United States - 1982", U. S. Geological Survey Circular 892, 73 p.

Schuster, J. E. and R. G. Bloomquist, 1994. "Low-Temperature Geothermal Resources of Washington", Washington Division of Geology and Earth Resources Open-File Report 94-11, 53 p.

Swanberg, C. A., 1980. "Chemistry, Origin, and Geothermal Potential of Thermal and Non-Thermal Groundwaters in New Mexico", unpublished report submitted under U. S. Geological Survey Grant 14-08-0001-6-255, 99 p.

Witcher, J. C., 1995a. "A Geothermal Resource Database, Arizona", Southwest Technology Development Institute, New Mexico State University, Technical Report to Oregon Institute of Technology, Geo-Heat Center, 18 p.

Witcher, J. C., 1995b. "A Geothermal Resource Database, New Mexico", Southwest Technology Development Institute, New Mexico State University, Technical Report to Oregon Institute of Technology, Geo-Heat Center, 32 p.

Youngs, L. G., 1994. "California Low-Temperature Geothermal Resources update - 1993", California Department of Conservation, Division of Mines and Geology, Technical Report to Oregon Institute of Technology, Geo-Heat Center, 25 p.

APPENDIX A

Database of Collocated Resources

Collocated Resources

Page 1

State	City	County	Pop.	Res. Temp C	Depth m	Flow L/min	TDS mg/L	Current use	HDD	Design Temp F	Contact Place
Arizona	Avondale	Maricopa	17595	50	457						Greater Phoenix Eco. Council
Arizona	Clifton	Greenlee	2840	71							Greenlee County Chamber of Commerce
Arizona	Coolidge	Pinal	6927	71.7	782	9251					Coolidge Eco. Dev. Board
Arizona	Guthrie	Greenlee		84							Greenlee County Chamber of Commerce
Arizona	Litchfield Park	Maricopa	3303	56.1	707						Greater Phoenix Eco. Council
Arizona	McNeal	Cochise	120	53.9	1283						Cochise County Eco. and Community Dev.
Arizona	Mesa	Maricopa	3E+05	54.4	305						Greater Phoenix Eco. Council
Arizona	Morristown	Yavapai	400	55.4		1287					Greater Phoenix Eco. Council
Arizona	Perryville	Maricopa		75	280	6057					Greater Phoenix Eco. Council
Arizona	Pima / Glenbar	Graham	1725	59	1148	3786					Gila Valley Eco. Dev. Found.
Arizona	San Simon	Cochise	519	134	2032						Cochise County Eco. and Community Dev.
Arizona	Sierra Vista	Cochise	37300	68							Cochise County Eco. and Community Dev.
Arizona	Tucson	Pima	4E+05	52.2	762	7041					Greater Tucson Eco. Council
Arizona	Wellton / Roll	Yuma	1066	60							Yuma Eco. Dev. Corp.
California	Alturas	Modoc	3260	86.1	896	303	1537	Space heating a local school.	6785	-1	Chamber of Commerce
California	Benton	Mono	190	57		800	320		7900	8	Mono County Chamber of Commerce
California	Bieber	Lassen	600	90	648	215	880	Direct use in baths/pools and augmenting water supply	2688	29	Lassen County Chamber of Commerce
California	Big Bend	Shasta	150	82	250	481	1940	Space heating for a local school.	5474	11	Eco. Dev. of Shasta
California	Bishop	Inyo	3490	58		2000	510		4313	16	Chamber of Commerce
California	Bombay Beach	Imperial	500	88	201	2660	3800	Aquaculture	925	38	Imperial County Community Eco. Dev.
California	Boyes Hot Springs / Sonoma	Sonoma	5937	53.1	396	757	1287	Direct use in baths/pools and space heating	3311	30	Sonoma Valley Chamber of Commerce

Collocated Resources

Page 2

State	City	County	Pop.	Res. Temp C	Depth m	Flow L/min	TDS mg/L	Current use	HDD	Design Temp F	Contact Place
California	Brawley	Imperial	19450	138	2545	500	28000		925	38	Imperial County Community Eco. Dev.
California	Bridgeport	Mono	900	82	300	450	4320	Power plant	6022	10	Mono County Chamber of Commerce
California	Byron	Contra Costa	1100	51	75	600			2806	30	Martinez Area Chamber of Commerce
California	Calexico	Imperial	19200	168	1531	8500	20000		925	38	Imperial County Community Eco. Dev.
California	Calipatria	Imperial	2700	360	1236	6900	390000		925	38	Imperial County Community Eco. Dev.
California	Calistoga	Napa	4500	138	244	4447	660	Space heating, baths/pools, bottled water, greenhouse, and augmenting water supply.	3065	29	Napa Valley Eco. Dev. Corp.
California	Canby	Modoc	450	116	1035	1250	900		6785	-1	Chamber of Commerce
California	Cedarville	Modoc	950	98	194	3225	1180	Space heating for 2 schools and a hospital, and baths/pools.	6255	3	Chamber of Commerce
California	Clear Lake	Lake	12100	187	2385	429	8000	Greenhouse	3065	29	Chamber of Commerce
California	Colton	San Bernardino	41350	58	259			District heating	1891	33	San Bernardino Area Chamber of Commerce
California	Coso Junction	Inyo	30	97	1980	7600	4600	Power plant	6800	10	Chamber of Commerce
California	Costa Mesa	Orange	97400	218	2777				1819	43	Orange County Chamber of Commerce & Ind.
California	Day	Modoc	50	73.5		300		Irrigation	5474	11	Chamber of Commerce
California	Desert Hot Springs	Riverside	12300	93	150	50	1000		2006	29	Riverside County Dev. Agency
California	Drakesbad	Plumas	40	129	387	897	4570		2688	29	Plumas Corp.
California	Eagleville	Modoc	185	56		500	370		5822	6	Chamber of Commerce
California	El Centro	Imperial	32650	168	1531	8500	20000		925	38	Imperial County Community Eco. Dev.
California	Fort Bidwell	Modoc	230	53	24		1060		6365	9	Imperial County
California	Gaviota	Santa Barbara	70	68					3053	33	Santa Barbara County Chamber of Commerce
California	Glamis	Imperial		71	207				925	38	Imperial County Community Eco. Dev.
California	Heber	Imperial	2566	168	1531	8500	20000		925	38	Imperial County Community Eco. Dev.
California	Hemet	Riverside	38000	54				baths/pools	1819	33	Riverside County Dev. Agency

State	City	County	Pop.	Res. Temp C	Depth m	Flow L/min	TDS mg/L	Current use	HDD	Design Temp F	Contact Place
California	Highlands	San Bernardino	35650	54	284	18900			1891	33	San Bernardino Area Chamber of Commerce
California	Holtville	Imperial	4820	204	1829	2400			925	38	Imperial County Community Eco. Dev.
California	Huntington Beach	Orange	2E+05	218	2777				1819	43	Orange County Chamber of Commerce & Ind.
California	Johannesburg	Kern	300	96	236			Power plant	2946	23	Kern Eco. Dev. Corp.
California	Kelseyville	Lake	2861	63.9	180.4	1900		Greenhouse/teaching facility and space heating.	3065	29	Chamber of Commerce
California	Kings Beach	Placer	2796	55		600	371	Bathing/pools	8290	-1	Truckee/Donner Chamber of Commerce
California	Lake City	Modoc	190	160	1508	1370	1210		6255	3	Chamber of Commerce
California	Lake Elsinore	Riverside	19200	54				baths/pools	1819	33	Riverside County Dev. Agency
California	Lake Isabella	Kern	3323	54		415	420	Direct use in baths/pools and augmenting water supply.	2185	32	Kern Eco. Dev. Corp.
California	Lee Vining	Mono	900	86	1220	270	25000		4313	11	Mono County Chamber of Commerce
California	Likely	Modoc	250	77		12	1220		6255	3	Chamber of Commerce
California	Litchfield	Lassen	350	79.4	434	3956		District heating system	6022	10	Lassen County Chamber of Commerce
California	Los Angeles / Encino	Los Angeles	3E+06	56			1690		2929	22	Eco. Dev. Corp.
California	Lower Lake	Lake	1217	187	2385	429	8000	Greenhouse	3065	29	Chamber of Commerce
California	Loyalton	Sierra	930	94	335	153	1600	Irrigation and direct use in baths/pools.	6022	10	Lassen County Chamber of Commerce
California	Mammoth Lakes	Mono	4900	177	487	15792	1530	District heating system	7900	8	Mono County Chamber of Commerce
California	Markleeville	Alpine	100	65		873	1720	Baths/pools and heat exchanger	7884	8	Alpine County Chamber of Commerce
California	Middleton / Cobb	Lake	2000	100		68	7770		3716	22	Chamber of Commerce
California	Mineral Hot Springs	Kern	40	50		49		Direct use in baths/pools and to augment water supply.	2185	32	Kern Eco. Dev. Corp.
California	Montecito	Santa Barbara	11500	56		760	690		2470	36	Santa Barbara County Chamber of Commerce
California	Newport Beach	Orange	67300	218	2777				1819	43	Orange County Chamber of Commerce & Ind.

State	City	County	Pop.	Res. Temp C	Depth m	Flow L/min	TDS mg/L	Current use	HDD	Design Temp F	Contact Place
California	Niland	Imperial	1183	348	1340	18000	340000		925	38	Imperial County Community Eco. Dev.
California	Ojai/Meiners Oaks	Ventura	7650	51		217	1110		2470	34	Ventura County Eco. Dev. Assn.
California	Randsburg	Kern	280	96	236				2946	23	Kern Eco. Dev. Corp.
California	Red Mountain	San Bernardino	200	96	236				2946	23	San Bernardino Area Chamber of Commerce
California	Salton City	Imperial	1100	59			2210		925	38	Imperial County Community Eco. Dev.
California	San Bernardino	San Bernardino	2E+05	90	167	605	1150	District heating system	1819	33	San Bernardino Area Chamber of Commerce
California	San Diego	San Diego	1E+06	73	1855				1507	44	San Diego Eco. Dev. Corp.
California	San Luis Obispo	San Luis Obispo	42600	55	609	189	815	baths/pools and space heating.	2472	33	Chamber of Commerce
California	Susanville	Lassen	7325	78.9	283	5144	690	District heating system	6248	4	Lassen County Chamber of Commerce
California	Tassajara Hot Springs	Monterey		60		189		Direct use in baths/pools.	3556	38	Eco. Dev. Corp. of Monterey County
California	Temecula	Riverside	27400	54				baths/pools	1532	39	Riverside County Dev. Agency
California	Trona	San Bernardino	1400	58	183		53900		2946	27	San Bernardino Area Chamber of Commerce
California	Twentynine Palms	San Bernardino	11950	63	122		1000		2006	29	City of Twenty-Nine Palms
California	Warner Springs	San Diego	30	56		500	244	baths/pools and space heating	1532	39	San Diego Eco. Dev. Corp.
California	Wendel	Lassen	100	107	334	8267	1040		5822	11	Lassen County Chamber of Commerce
California	Westmorland	Imperial	1400	56	378	160	3020		925	38	Imperial County Community Eco. Dev.
California	Widomar	Riverside	10411	54				Baths/pools	1819	33	Riverside County Dev. Agency
California	Wilbur Springs	Colusa	10	175	2712	330	25900	Direct use in baths/pools	2166	30	Chamber of Commerce
California	Winchester	Riverside	1689	54				Baths/pools	1819	33	Riverside County Dev. Agency
California	Yorba Linda	Orange	60700	73			590		2166	30	Orange County Chamber of Commerce & Ind.
Colorado	Buena Vista	Chaffee	1752	54	34.8	1705	301	Bathing (developed), space heating, and greenhouse.	7734	-3	Heart of the Rockies Chamber of Commerce

Collocated Resources

Page 5

State	City	County	Pop.	Res. Temp C	Depth m	Flow L/min	TDS mg/L	Current use	HDD	Design Temp F	Contact Place
Colorado	Chromo	Archuleta	115	60	521.2	350	1270	Agricultural irrigation.	8274	2	Archuleta County Eco. Dev. Assn.
Colorado	Florence / Portland	Fremont	2990	55	332.1	330	1398	Bathing.	4836	-3	Fremont County Eco. Dev. Corp.
Colorado	Glenwood Springs	Garfield	6561	51		6151	18890	Bathing (Developed).	5605	7	Glenwood Springs Chamber Resort Assn.
Colorado	Hartsel	Park	100	52			2280	Bathing (Not developed).	5394	0	Heart of the Rockies Chamber of Commerce
Colorado	Mineral Hot Springs / Villa Grove	Saguache	50	60		429	651		5394	0	Fremont County Eco. Dev. Corp.
Colorado	Mt. Princeton H. S. / Nathrop	Chaffee	150	83	54.5	151	344	Bathing (developed), space heating, and greenhouse.	7734	-3	Heart of the Rockies Chamber of Commerce
Colorado	Ouray	Ouray	644	67		290	1350	Bathing (developed) and space heating.	6373	7	Ouray Chamber Resort Assn.
Colorado	Pagosa Springs	Archuleta	1207	57	151.5	1400	3320	Bathing (developed) and space heating.	5402	5	Archuleta County Eco. Dev. Assn.
Colorado	Poncha Springs	Chaffee	244	70		864	674	Bathing (developed).	5978	7	Heart of the Rockies Chamber of Commerce
Colorado	Ridgeway	Ouray	423	50		1500	2370	Bathing (developed).	5978	7	Ouray Chamber Resort Assn.
Colorado	Steamboat Spring / Mad Creek	Routt	6695	64		284	539	Bathing (developed).	9595	-5	Steamboat Springs Chamber Resort Assn.
Colorado	Wagon Wheel Gap / Creede	Mineral	362	55		120	1583	Bathing (developed).	6016	1	Creede-Mineral County Chamber of Commerce
Colorado	Waunita Hot Springs / White Pine	Gunnison	50	70		741	540	Bathing.	6473	2	Gunnison County Chamber of Commerce
Colorado	Waunita Hot Springs / White Pine	Gunnison	50	78		1171	604	Bathing (developed) and space heating.	6473	2	Gunnison County Chamber of Commerce
Idaho	Albion	Cassia	305	60	136		372		6731	2	Mini-Cassia Dev. Commission
Idaho	Almo	Cassia	100	60			377		6401	-3	Mini-Cassia Dev. Commission
Idaho	Alpha	Valley	877	63					6887	-3	Chamber of Commerce
Idaho	Atlanta	Elmore	70	60			240		7630	3	Ida-Ore Planning & Dev. Assn.

State	City	County	Pop.	Res. Temp C	Depth m	Flow L/min	TDS mg/L	Current use	HDD	Design Temp F	Contact Place
Idaho	Bancroft	Caribou	393	54	63		757		7083	-8	Caribou County Eco. Dev. Corp.
Idaho	Bates	Teton	100	70	2003		590		9030	-11	Teton Valley Chamber of Commerce
Idaho	Boise	Ada	1E+05	90	391		293	District heating system.	5833	10	Ida-Ore Planning & Dev. Assn.
Idaho	Bowmont	Canyon	80	51	96.9		385		5594	3	Ida-Ore Planning & Dev. Assn.
Idaho	Bridge	Cassia		146	823	540	1478		6401	-3	Mini-Cassia Dev. Commission
Idaho	Bruneau	Owyhee	125	50					6353	-1	Ida-Ore Planning & Dev. Assn.
Idaho	Buhl	Twin Falls	3516	72	180		451	Residential heating, catfish and tropical fish production, greenhouse, swimming pool and spa.	6146	2	Region IV Dev. Assn.
Idaho	Caldwell	Canyon	18400	66.7	650				5736	10	Ida-Ore Planning & Dev. Assn.
Idaho	Cambridge	Washington	374	70					5707	10	Washington County Eco. Dev. Comm.
Idaho	Carey	Blaine	500	52			401		8653	-3	Chamber of Commerce
Idaho	Challis	Custer	1073	50			635		7761	-6	Stanley-Sawtooth Chamber of Commerce
Idaho	Cleveland / Perry	Franklin		55			2554		8305	-8	Preston Community Dev.
Idaho	Corral	Camas	25	72.8	18		343		8692	0	Chamber of Commerce
Idaho	Crouch	Boise	75	84	58			Greenhouses, resort facilities and numerous houses.	6577	3	Ida-Ore Planning & Dev. Assn.
Idaho	Dingle	Bear Lake	200	56	12		464		8948	-11	Greater Bear Lake Valley Chamber of Commerce
Idaho	Eagle	Ada	3327	61	104		210		6027	4	Ida-Ore Planning & Dev. Assn.
Idaho	Garden Valley	Boise	375	81			263	Greenhouses, resort facilities and numerous houses.	5507	10	Ida-Ore Planning & Dev. Assn.
Idaho	Gimlet / Hailey	Blaine	3687	50				Swimming.	8251	-3	Chamber of Commerce
Idaho	Grandview	Owyhee	330	84	768		400	Space heating.	5507	8	Ida-Ore Planning & Dev. Assn.
Idaho	Hailey	Blaine	3687	73			210	Swimming pool and space heating.	5732	8	Chamber of Commerce
Idaho	Ketchum	Blaine	2523	70.5		1.59		Space heating and swimming pool.	6164	2	Chamber of Commerce

Collocated Resources

Page 7

State	City	County	Pop.	Res. Temp C	Depth m	Flow L/min	TDS mg/L	Current use	HDD	Design Temp F	Contact Place
Idaho	Lanark / Ovid	Bear Lake	125	51	29		335		8948	-11	Greater Bear Lake Valley Chamber of Commerce
Idaho	Lowman	Boise	50	65			281	Bathing, space heating, and greenhouses.	5507	10	Ida-Ore Planning & Dev. Assn.
Idaho	Magic City	Blaine	50	74.5					8706	0	Chamber of Commerce
Idaho	Malta / Keogh	Cassia	171	77					6401	-3	Mini-Cassia Dev. Commission
Idaho	Midvale	Washington	110	51		780	15000		6887	3	Washington County Eco. Dev. Comm.
Idaho	Murphy Hot Springs	Owyhee	150	52					6584	-1	Ida-Ore Planning & Dev. Assn.
Idaho	New Meadows	Adams	534	71			631		5833	3	Chamber of Commerce
Idaho	Newdale	Fremont	377	87					7788	-6	South Fremont Chamber of Commerce
Idaho	Obsidian	Custer		50					8251	-3	Stanley-Sawtooth Chamber of Commerce
Idaho	Oreana	Owyhee		75	864				5519	3	Ida-Ore Planning & Dev. Assn.
Idaho	Payette	Payette	5592	57.2	846				5709	4	Ida-Ore Planning & Dev. Assn.
Idaho	Pine	Elmore	60	60			213		6362	0	Ida-Ore Planning & Dev. Assn.
Idaho	Preston	Franklin	3710	82	2	3594	13167		7325	-1	Preston Community Dev.
Idaho	Soda Springs	Caribou	3111	51	19		2580		8305	-8	Caribou County Eco. Dev. Corp.
Idaho	Stanley	Custer	71	58			253		7761	-6	Stanley-Sawtooth Chamber of Commerce
Idaho	Star	Ada	600	174.4	4270				5833	3	Ida-Ore Planning & Dev. Assn.
Idaho	Starkey / Fruitvale	Adams	100	55					8774	-1	Chamber of Commerce
Idaho	Sunbeam	Custer	40	76.5					7761	-6	Stanley-Sawtooth Chamber of Commerce
Idaho	Swan Valley	Bonneville	141	140	4931				8021	-11	Eastern Idaho Eco. Dev. Council
Idaho	Sweet	Gem	200	66					6577	3	Ida-Ore Planning & Dev. Assn.
Idaho	Tendoy	Lemhi	200	63.5			839		7620	-1	Salmon Valley Chamber of Commerce

State	City	County	Pop.	Res. Temp C	Depth m	Flow L/min	TDS mg/L	Current use	HDD	Design Temp F	Contact Place
Idaho	Thatcher	Caribou	110	50	20		909		8305	-8	Caribou County Eco. Dev. Corp.
Idaho	Wardboro / Montpelier	Bear Lake	2656	74	3500				8948	-11	Greater Bear Lake Valley Chamber of Commerce
Idaho	Warm Lake / Knox	Valley	50	59			246		6146	-6	Chamber of Commerce
Idaho	Weiser	Washington	4571	77	95				5707	10	Washington County Eco. Dev. Comm.
Idaho	Woodruff	Onieda		63			14000		7455	-8	Onieda County Bus. Asst. Corp.
Montana	Alhambra	Jefferson	100	56.5		490	909		8354	-10	Helena Area Eco. Dev. Corp.
Montana	Boulder	Jefferson	1316	74	38.1	415.7	421.14	Recreation	8354	-10	Helena Area Eco. Dev. Corp.
Montana	Bozeman	Gallatin	24400	59	164.6	1296	434.4	Recreation and research.	8586	-16	Bozeman Area Chamber of Commerce
Montana	Colstrip	Rosebud	3035	96.1	371.9	18.6	1394.9	Unused	9251	-23	Colstrip Merchants Assn.
Montana	Corwin Springs	Park	20	65		500	2230		9719	-17	Park County Eco. Dev. Corp.
Montana	Crackerville / Anaconda	Silver Bow	10278	61.5		946.3		Industrial/commercial	9719	-24	Butte-Silverbow Chamber of Commerce
Montana	Ennis	Madison	773	87	371.9	28.6	966.38	Industrial/commercial, research and one is unused.	8586	-16	Chamber of Commerce
Montana	Helena	Lewis and Clark	26400	65.5		227	598	Greenhouse	8190	-21	Helena Area Eco. Dev. Corp.
Montana	Hot Springs	Sanders	411	51.5		1727	413.14	Research and industrial/commercial	11024	-31	Chamber of Commerce
Montana	Jackson	Beaverhead	75	60		1000	655.43	Domestic	9719	-17	Beaverhead Chamber of Commerce
Montana	Marysville	Lewis and Clark	70	96.7	2070		672.39	Unused	9719	-17	Helena Area Eco. Dev. Corp.
Montana	Norris	Madison	35	50		424	651		8586	-16	Chamber of Commerce
Montana	Raderburg	Deer Lodge	60	77		600	1310		8190	-21	Chamber of Commerce
Montana	Rapelie	Stillwater	100	69		1100	2810		7265	-15	Chamber of Commerce
Montana	Springdale	Park	30	60		5000	384		9033	-20	Park County Eco. Dev. Corp.
Montana	Warm Springs / Anaconda	Deer Lodge	10278	79		73.4	1273.4	Research	9719	-17	Chamber of Commerce
Montana	Whitehall	Jefferson	1067	50		151	655		9719	-24	Helena Area Eco. Dev. Corp.

Collocated Resources

Page 9

State	City	County	Pop.	Res. Temp C	Depth m	Flow L/min	TDS mg/L	Current use	HDD	Design Temp F	Contact Place
Montana	Wolf Point	Roosevelt	2880	51	32	100.1	1234.5	Other	9251	-22	Wolf Point Chamber of Commerce & Ag.
Nevada	Beowawe	Eureka	250	98		387.7	1000	16 MW power plant.	7483	-2	Eureka County Chamber of Commerce
Nevada	Caliente	Lincoln	1111	67	27	5299		Spa.	6022	10	Chamber of Commerce
Nevada	Carlin	Elko	2220	79				Space Heating.	7483	-2	North East Nevada Dev. Auth.
Nevada	Carson City	Carson City	43900	50				Spa and Pool.	5766	4	Northern Nevada Dev. Auth.
Nevada	Carvers	Nye		90.5	244			Heap leaching.	6180	0	Chamber of Commerce
Nevada	Cherry Creek	White Pine	50	61					7814	-4	White Pine County Eco. Diversification Program
Nevada	Cobre / Oasis	Elko		76.7	1403				7483	-2	North East Nevada Dev. Auth.
Nevada	Contact	Elko		60					7096	-13	North East Nevada Dev. Auth.
Nevada	Crescent Valley	Eureka	70	60		125			6420	-8	Eureka County Chamber of Commerce
Nevada	Denio	Humboldt	50	83		3785	262		7205	-13	Tri-County Dev. Auth.
Nevada	Elko	Elko	14736	80		75	582	Space heating and district heating. Space heating- 16 commercial and 2 residential.	7483	-2	North East Nevada Dev. Auth.
Nevada	Fallon	Churchill	6438	93.7	56.7				5229	12	Churchill Eco. Auth.
Nevada	Gabba	Nye	667	54	84				5508	11	Chamber of Commerce
Nevada	Gerlach	Washoe	250	89.5		490.5		Vegatable dehydration plant, spa and space heating.	5806	3	Eco Dev. Auth of Western Nevada
Nevada	Golconda	Humboldt	200	74	78.6	750			6629	3	Tri-County Dev. Auth.
Nevada	Hazen	Lyon	30	86.1			2100		5229	12	Mason Valley Chamber of Commerce
Nevada	Humboldt	Pershing		162.3	565		4530	Heap leaching.	5806	-1	Tri-County Dev. Auth.
Nevada	Lovelock / Colado	Pershing	2069	60					5836	-1	Tri-County Dev. Auth.
Nevada	Minden / Genoa	Douglas	1441	63		132	499	Spa.	5753	9	Northern Nevada Dev. Auth.
Nevada	Reno	Washoe	60	88	60		959	Space heating and pool. 300 homes use space heating and 130 others use district heating.	6030	8	Eco Dev. Auth of Western Nevada
Nevada	Rowland	Elko		77		114	442		7205	-8	North East Nevada Dev. Auth.

State	City	County	Pop.	Res. Temp C	Depth m	Flow L/min	TDS mg/L	Current use	HDD	Design Temp F	Contact Place
Nevada	Steamboat	Washoe	300	113	113	50	2056	31.1 MW power plants and space heating.	6030	5	Eco Dev. Auth of Western Nevada
Nevada	Stewart	Carson City	5164	50					5753	4	Northern Nevada Dev. Auth.
Nevada	Stillwater	Churchhill	60	96	19.8			13 MW power plant.	5229	12	Churchill Eco. Dev. Auth.
Nevada	Virginia City	Story	920	76.7	914				5753	9	Eco Dev. Auth of Western Nevada
Nevada	Wabuska	Lyon	100	97.2	149	5731	1210	1.2 MW power plant.	5592	4	Mason Valley Chamber of Commerce
Nevada	Warm Springs	White Pine	20	79			518		7814	-4	Chamber of Commerce
Nevada	Warm Springs	Nye	20	63		170	833		7814	20	White Pine County Eco. Diversification Program
Nevada	Wells	Elko	1256	61				Heat pump.	7483	-2	North East Nevada Dev. Auth.
Nevada	Wild Horse	Elko	20	54					7483	-2	North East Nevada Dev. Auth.
New Mexico	Cotton City	Hidalgo		107.2	134.1	757	1180.5	Largest greenhouse in the nation	3392	18	Lordsburg-Hidalgo County Chamber of Commerce
New Mexico	Faywood	Grant	50	53		9.84			3392	18	Silver City-Grant County Eco. Dev. Corp.
New Mexico	Fort Wingate	McKinley	950	55	592.3	87.06			5915	4	NW New Mexico Cncl. of Gov'ts
New Mexico	Hurley	Grant	1534	62.2	158.5				3392	18	Silver City-Grant County Eco. Dev. Corp.
New Mexico	Jemez Springs	Sandoval	413	73.3		196.9	2220		4337	16	Sante Fe Eco. Dev. Inc.
New Mexico	Jemez / San Ysidro	Sandoval	1301	57.8	73.2	567.8	3366		4337	16	Sante Fe Eco. Dev. Inc.
New Mexico	Las Cruces	Dona Ana	68400	69.4	784.3	12.62	2004	District heating at NMSU, greenhouse, aquaculture and space heating	3194	20	Dona Ana County Eco. Dev. Dept.
New Mexico	Las Vegas	San Miguel	14753	55.17			537		4337	16	Las Vegas-SanMiguel Chamber of Commerce
New Mexico	Ojo Caliente / Gallegos	Rio Arriba	500	55.6	26.5		3618		4337	16	NW New Mexico Cncl. of Gov'ts
New Mexico	Radium Springs	Dona Ana	100	76.7	36.6		3944.3	Second largest greenhouse in the nation.	3194	20	Dona Ana County Eco. Dev. Dept.
New Mexico	San Juan / Sherman	Grant		59		9.84	308		3392	18	Silver City-Grant County Eco. Dev. Corp.
New Mexico	Valencia	Valencia	3917	80	219.5		3440		4337	16	Valencia County Eco. Dev. Corp.

Collocated Resources

Page 11

State	City	County	Pop.	Res. Temp C	Depth m	Flow L/min	TDS mg/L	Current use	HDD	Design Temp F	Contact Place
Oregon	Adel	Lake	75	121	196				7609	7	Lake County Chamber of Commerce
Oregon	Adrain	Malheur	131	79	410	60			5534	10	Malheur County Eco. Dev. Dept.
Oregon	Beulah	Malheur		60		50			7212	0	Malheur County Eco. Dev. Dept.
Oregon	Bonanza	Klamath	323	94	70				6516	9	Klamath County Chamber
Oregon	Breitenbush H.S/ Idanha	Marion	289	89	310	3408		Space heating and spas	4792	17	Salem Eco. Dev. Corp.
Oregon	Burns	Harney	2913	71	695.5				7212	6	Harney County Chamber of Commerce
Oregon	Crane	Harney	150	82	50	700			7212	6	Harney County Chamber of Commerce
Oregon	Fields	Harney	20	97		20			7212	6	Harney County Chamber of Commerce
Oregon	Government Camp	Clackamas	350	121	1426	416			4792	17	Clackamas County Dev. Agency
Oregon	Haines	Baker	405	57	37.5	1150			6909	9	Baker City/County Eco. Dev. Dept.
Oregon	Harney	Harney		72	286.5	1000			7212	6	Harney County Chamber of Commerce
Oregon	Harper / Little Valley	Malheur	150	70	125	550			5707	10	Malheur County Eco. Dev. Dept.
Oregon	Jefferson	Linn	1805	58	1498				4854	18	Millersburg Eco. Dev. Corp.
Oregon	Kehneeta	Wasco	100	56					6643	-1	Mid-Columbia Eco. Dev. Dist.
Oregon	Klamath Falls	Klamath	37191	152	200	8377	902	District heating system, space heating, greenhouses	6516	9	Klamath County Chamber
Oregon	Lakeview	Lake	2526	113	184	6539		Greenhouse	7609	7	Lake County Chamber of Commerce
Oregon	Lawen	Harney	60	57	558.5	35			7212	6	Harney County Chamber of Commerce
Oregon	Lehman Springs	Umatilla		61					5240	-2	Greater Eastern Oregon Dev. Corp.
Oregon	Lorella	Klamath		61		150			6516	9	Klamath County Chamber
Oregon	McCreadie Hot springs	Lane		73		75			4739	17	Lane Cncl of Gov'ts.

Collocated Resources

State	City	County	Pop.	Res. Temp C	Depth m	Flow L/min	TDS mg/L	Current use	HDD	Design Temp F	Contact Place
Oregon	McKenzie Bridge	Lane	300	89	130	395			4739	17	Lane Cncl of Gov'ts.
Oregon	New Pine Creek	Lake	395	89	170	15000			7609	7	Lake County Chamber of Commerce
Oregon	Nyssa	Malheur	2629	84	478				5707	10	Malheur County Eco. Dev. Dept.
Oregon	Ontario	Malheur	10400	168	3064				5707	10	Malheur County Eco. Dev. Dept.
Oregon	Paisley	Lake	350	111	210	75		Irrigation	6377	7	Lake County Chamber of Commerce
Oregon	Pondosa / Medical Springs	Union		61		200			6069	9	Union County Eco. Dev. Corp.
Oregon	Powell Butte	Crook	600	57	461				6643	-1	Prineville-Crook County Chamber of Commerce
Oregon	Riverside	Malheur	15	63		225			5707	10	Malheur County Eco. Dev. Dept.
Oregon	Silverton / Scott Mills	Marion	5635	72	2379				4852	18	Salem Eco. Dev. Corp.
Oregon	Sumpter/Bourne	Baker	119	57	105				5240	-2	Baker City/County Eco. Dev. Dept.
Oregon	Union	Union	1847	85		6155		RV park	6069	9	Union County Eco. Dev. Corp.
Oregon	Vale	Malheur	1491	115	80.75	2914			5879	10	Malheur County Eco. Dev. Dept.
Utah	Bear River City	Box Elder	700	107	3354				6170	1	Brigeagle Realty
Utah	Beryl	Iron	75	149	3748	3785	4000		6248	-2	Cedar City/Iron County Ind. Dev.
Utah	Bluffdale	Salt Lake	1300	85	225	4164	1754	Used for greenhouses and state prison.	5573	-4	Metro Utah, Inc.
Utah	Clinton	Davis	7945	59			8955		6006	1	Bountiful Area Chamber of Commerce
Utah	Corinne	Box Elder	639	74	153	151	3350		6170	1	Brigeagle Realty
Utah	Cove Fort / Sulphurdale	Millard		178	1195		9405	Used for electric power.	6743	0	Fillmore City Eco. Dev.
Utah	Eureka	Juab	562	54.4		10200	6610		7015	-4	Community Eco. Dev. Agency
Utah	Fairview	San Pete	960	55	2776	1109	302		6199	-4	Commission for Eco. Dev. in Orem
Utah	Goshen	Utah	578	61			1200		5737	1	Commission for Eco. Dev. in Orem

State	City	County	Pop.	Res. Temp C	Depth m	Flow L/min	TDS mg/L	Current use	HDD	Design Temp F	Contact Place
Utah	Honeyville	Box Elder	1112	54.7		3600	43600		6807	2	Brigeagle Realty
Utah	Jensen	Uintah	450	56					7600	1	Vernal Area Chamber of Commerce
Utah	Joseph	Sevier	198	63		121			6394	-11	Richfield Area Chamber of Commerce
Utah	Logan	Cache	32762	54.9	55	71.9			6751	1	Cache Econ. Dev.
Utah	Meadow / Hatton	Millard	250	67	27	14.4	4848		6431	-2	Fillmore City Eco. Dev.
Utah	Monroe / Austin	Sevier	1472	82	1082			Used for bathing and swimming.	6394	1	Richfield Area Chamber of Commerce
Utah	Newcastle	Iron	200	97.2	152	5700	1236	Used for greenhouses.	6248	-2	Cedar City/Iron County Ind. Dev.
Utah	Newton / Trenton	Cache	659	51	1587	284	3784		7065	1	Cache Econ. Dev.
Utah	North Ogden	Weber	11668	58.5		121	21600		5973	1	Weber Eco. Dev. Corp.
Utah	Ogden	Weber	68400	56.6		20	8735		5866	1	Weber Eco. Dev. Corp.
Utah	Ouray	Uintah	35	57.5	1711				7209	1	Vernal Area Chamber of Commerce
Utah	Plymouth	Box Elder	267	52		6050	8420		6807	2	Brigeagle Realty
Utah	Riverton / Alpine	Salt Lake	11261	79			1242		5802	3	Metro Utah, Inc.
Utah	Salt Lake City / Sandy	Salt Lake	2E+05	55		870	14710		5802	2	Metro Utah, Inc.
Washington	Hanford Works	Benton		60.2	1324				5945	1	Prosser Eco. Dev. Assn.
Washington	Home Valley	Skamania	30	50					6814	19	Skamania County Eco. Dev. Cncl.
Washington	Hyak	King	300	50			391		9396	21	Eco. Dev. Cncl. of Seattle and King County
Washington	Irby	Lincoln	10	65.8	1343				6224	1	Chamber of Commerce
Washington	Mattawa	Grant	299	73.5	1525				6402	1	Big Bend Eco. Dev. Cncl.
Washington	Oroville	Okanogan	1505	50					6816	1	Chamber of Commerce

APPENDIX B

State Maps of Collocated Resources

ARIZONA COMMUNITIES WITH GEOTHERMAL RESOURCE DEVELOPMENT POTENTIAL

(Geothermal Resources with Temperatures > 50°C)

1995

T Boyd
Geo-Heat Center

EXPLANATION

The cities and towns of Arizona shown on this map are located within 5 miles of a known geothermal resource that has a temperature greater than 50°C (122°F).

LEGEND

- Thermal well
- ◆ Thermal spring

Temp, °C / Depth, m
Flow, L/min / TDS, mg/L

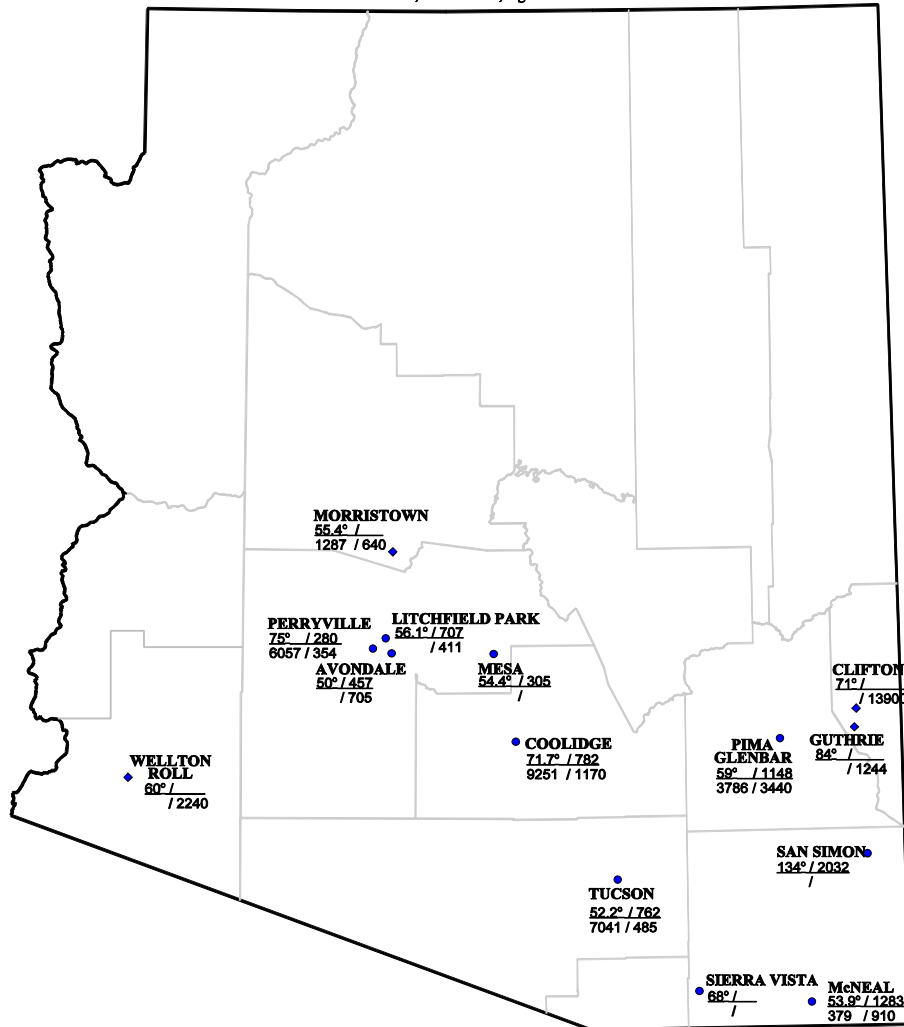

CALIFORNIA COMMUNITIES WITH GEOTHERMAL RESOURCE DEVELOPMENT POTENTIAL

(Geothermal Resources with Temperatures > 50°C)

1995

T Boyd
Geo-Heat Center
EXPLANATION

The cities and towns of California shown on this map are located within 5 miles of a known geothermal resource that has a temperature greater than 50°C (122°F).

LEGEND

- Thermal well
- ◆ Thermal spring

Temp. °C / Depth, m
Flow, L/min / TDS, mg/L

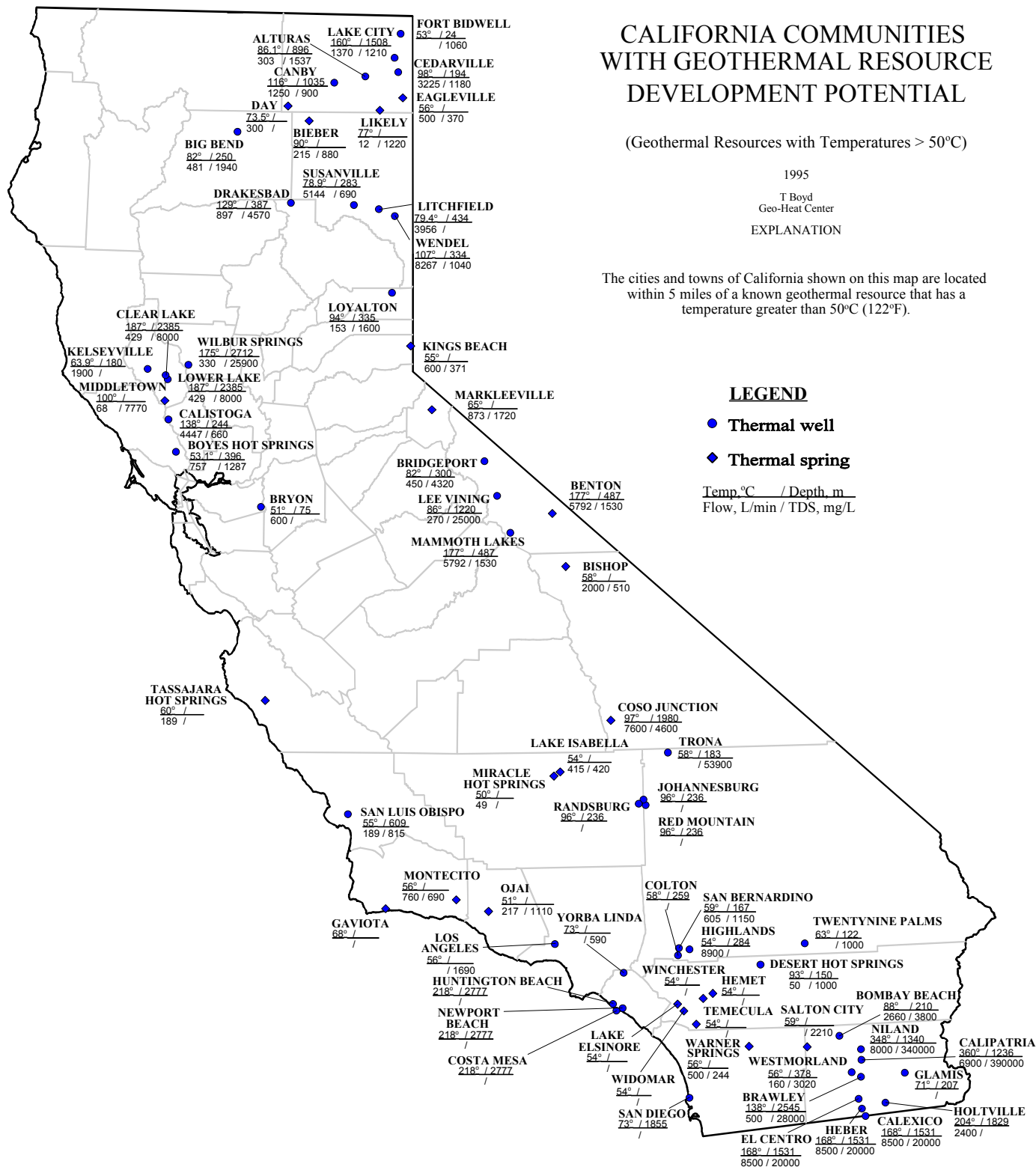

COLORADO COMMUNITIES WITH GEOTHERMAL RESOURCE DEVELOPMENT POTENTIAL

(Geothermal Resources with Temperatures > 50°C)

1995

T Boyd
Geo-Heat Center

EXPLANATION

The cities and towns of Colorado shown on this map are located within 5 miles of a known geothermal resource that has a temperature greater than 50°C (122°F).

LEGEND

- Thermal well
- ◆ Thermal spring

Temp, °C / Depth, m
Flow, L/min / TDS, mg/L

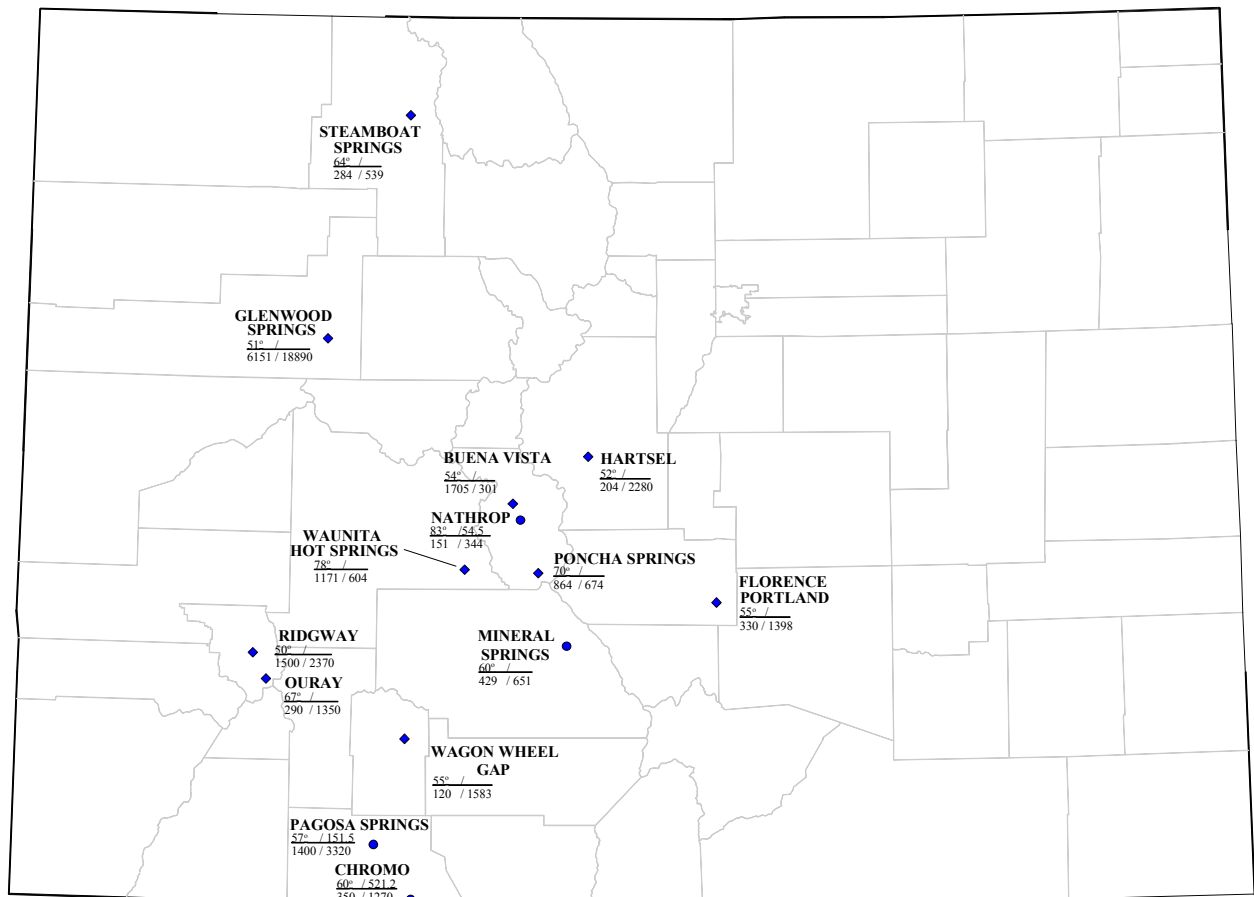

IDAHO COMMUNITIES WITH GEOTHERMAL RESOURCE DEVELOPMENT POTENTIAL

(Geothermal Resources with Temperatures > 50°C)

1995

T Boyd
Geo-Heat Center

EXPLANATION

The cities and towns of Idaho shown on this map are located within 5 miles of a known geothermal resource that has a temperature greater than 50°C (122°F).

LEGEND

- Thermal well
- ◆ Thermal spring

Temp. °C / Depth, m
Flow, L/min / TDS, mg/L

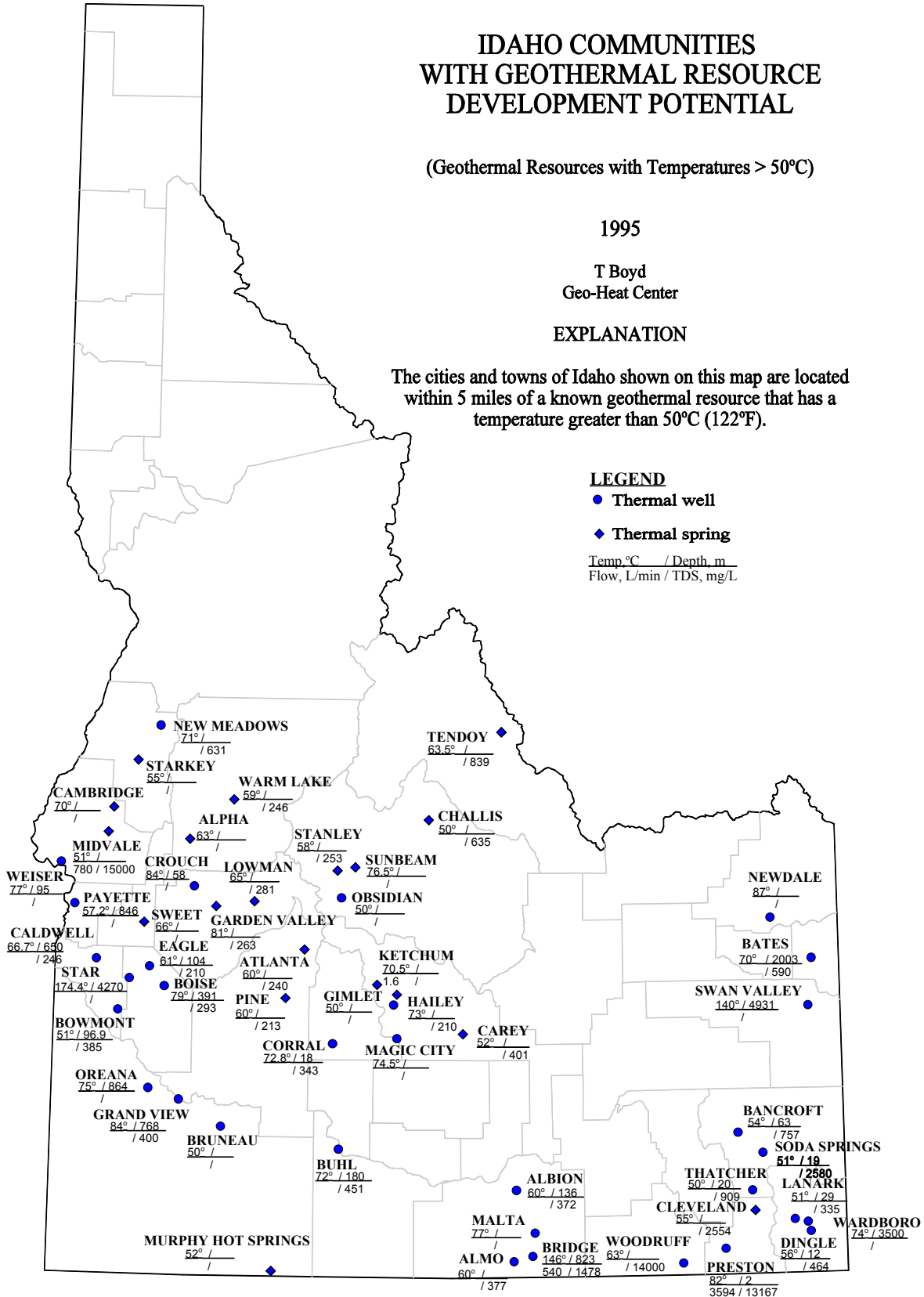

MONTANA COMMUNITIES WITH GEOTHERMAL RESOURCE DEVELOPMENT POTENTIAL

(Geothermal Resources with Temperatures > 50°C)

1995

T Boyd
Geo-Heat Center

EXPLANATION

The cities and towns of Montana shown on this map are located within 5 miles of a known geothermal resource that has a temperature greater than 50°C (122°F).

LEGEND

- Thermal well
- ◆ Thermal spring

Temp.°C / Depth_m
Flow_L/min/ TDS_mg/L

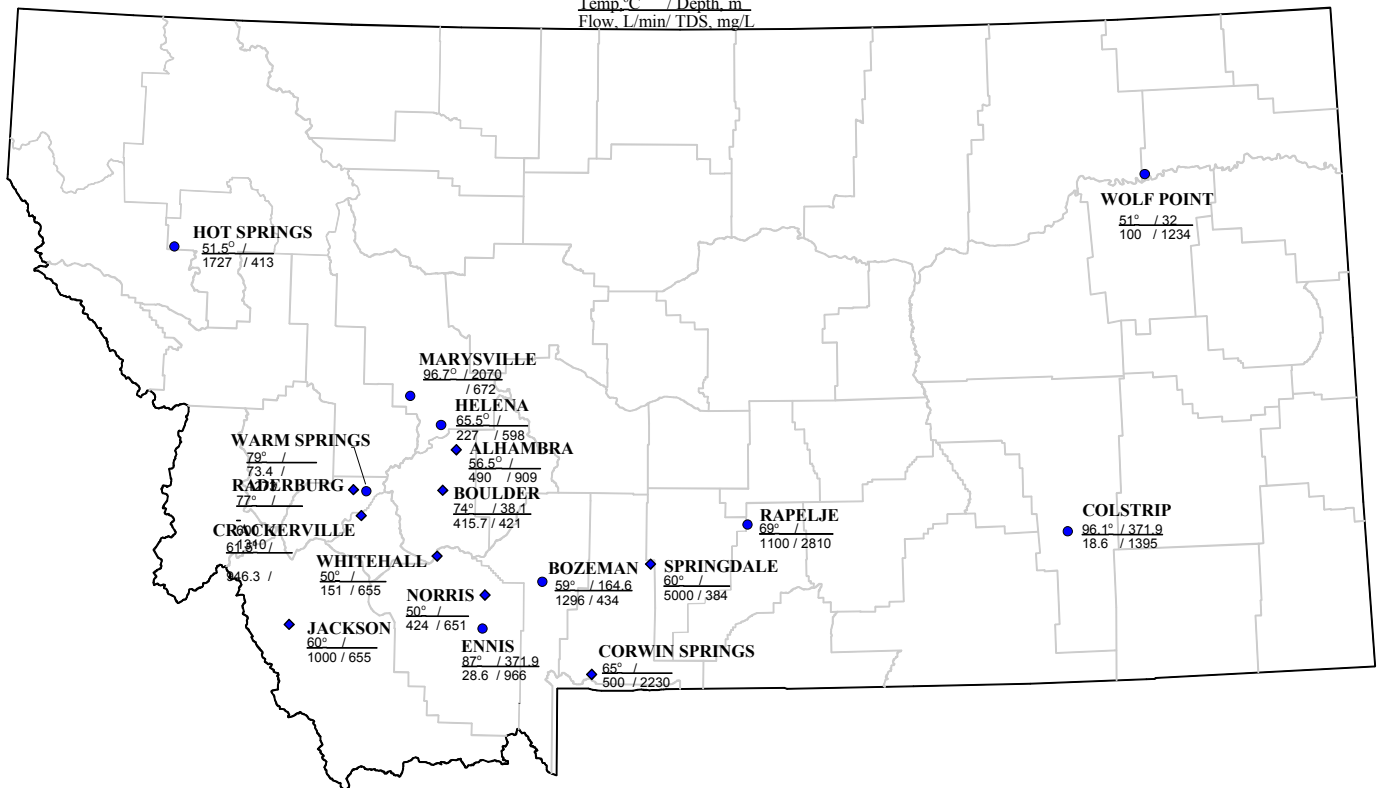

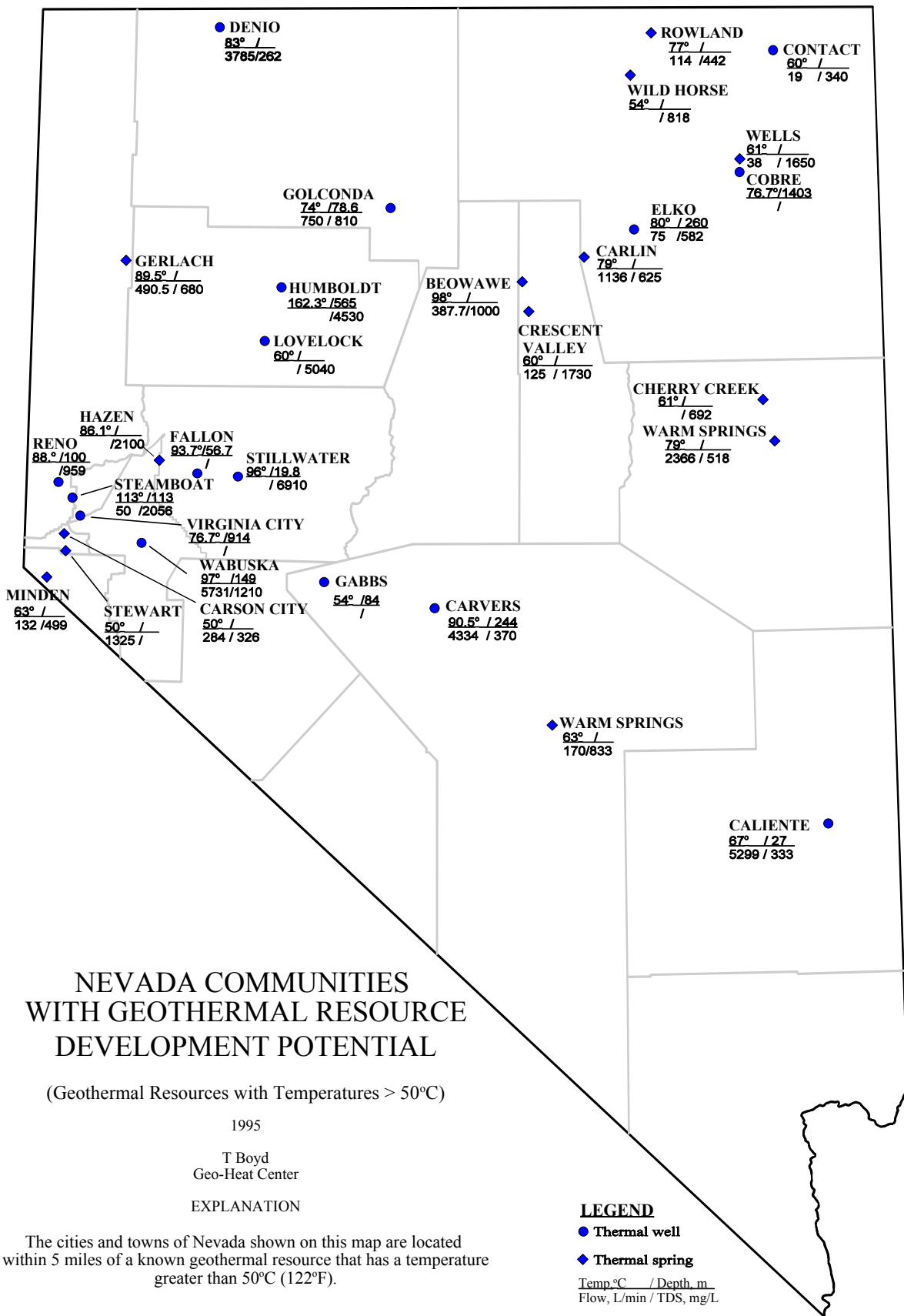

NEW MEXICO COMMUNITIES WITH GEOTHERMAL RESOURCE DEVELOPMENT POTENTIAL

(Geothermal Resources with Temperatures > 50°C)

1995

T Boyd
Geo-Heat Center

EXPLANATION

The cities and towns of Montana shown on this map are located within 5 miles of a known geothermal resource that has a temperature greater than 50°C (122°F).

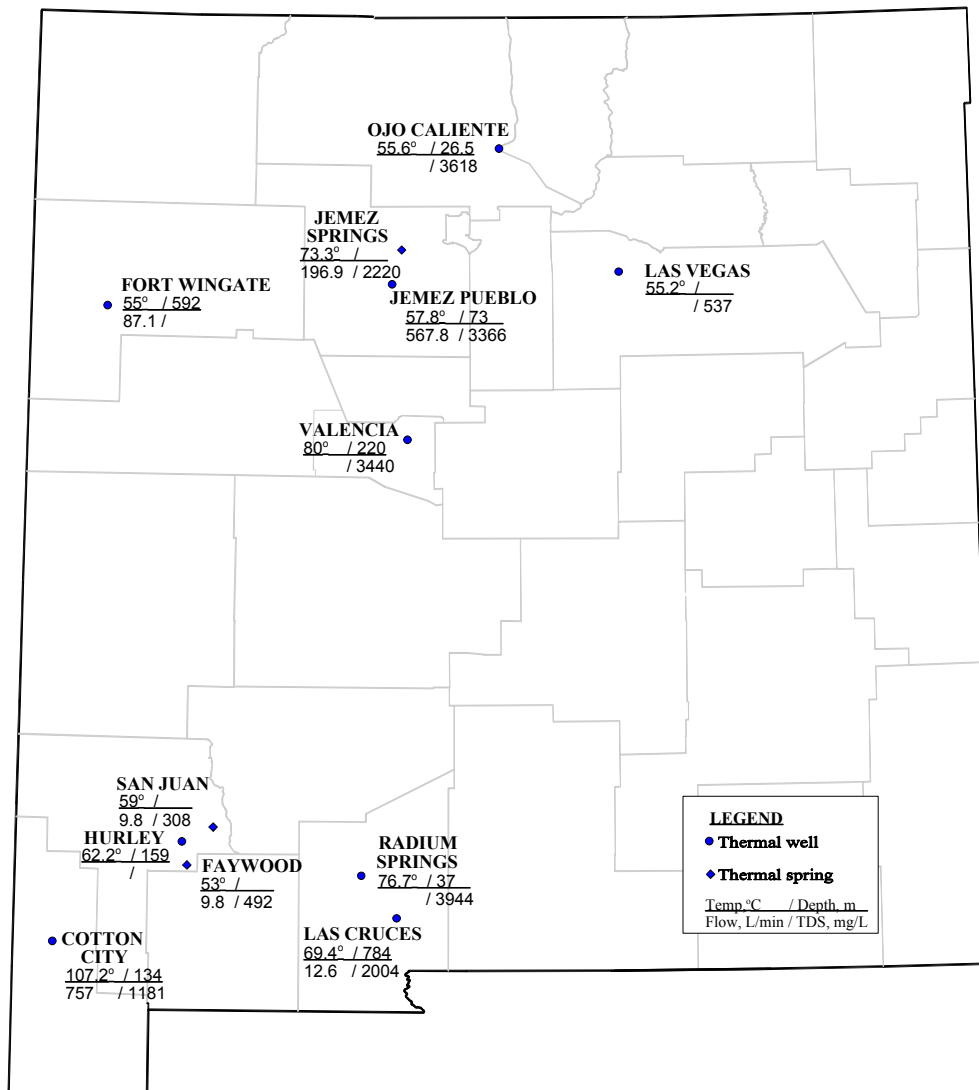

OREGON COMMUNITIES WITH GEOTHERMAL RESOURCE DEVELOPMENT POTENTIAL

(Geothermal Resources with Temperatures > 50°C)

1995

T Boyd
Geo-Heat Center

EXPLANATION

The cities and towns of Oregon shown on this map are located within 5 miles of a known geothermal resource that has a temperature greater than 50°C (122°F).

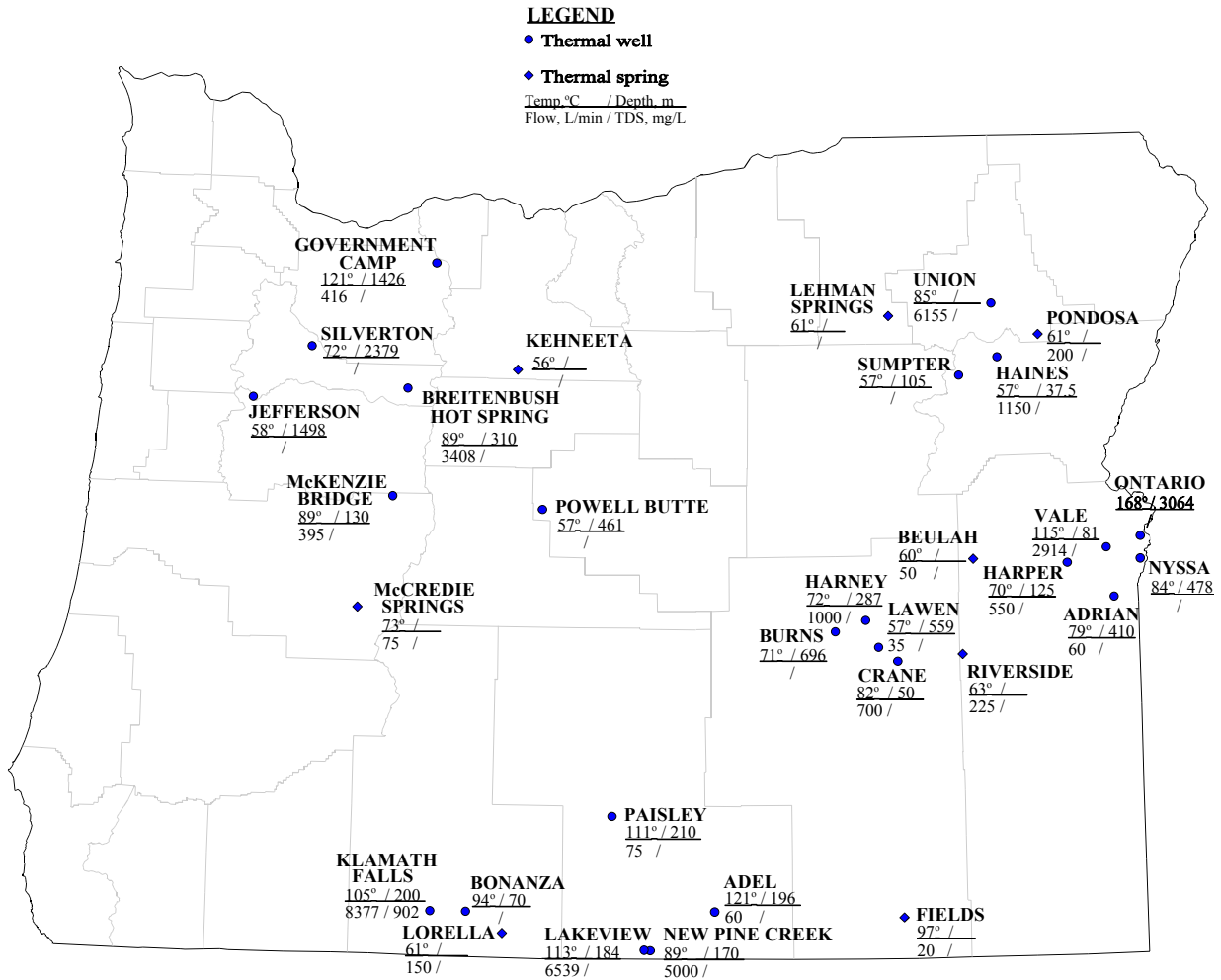

UTAH COMMUNITIES WITH GEOTHERMAL RESOURCE DEVELOPMENT POTENTIAL

(Geothermal Resources with Temperatures > 50°C)

1995

T Boyd
Geo-Heat Center

EXPLANATION

The cities and towns of Utah shown on this map are located within 5 miles of a known geothermal resource that has a temperature greater than 50°C (122°F).

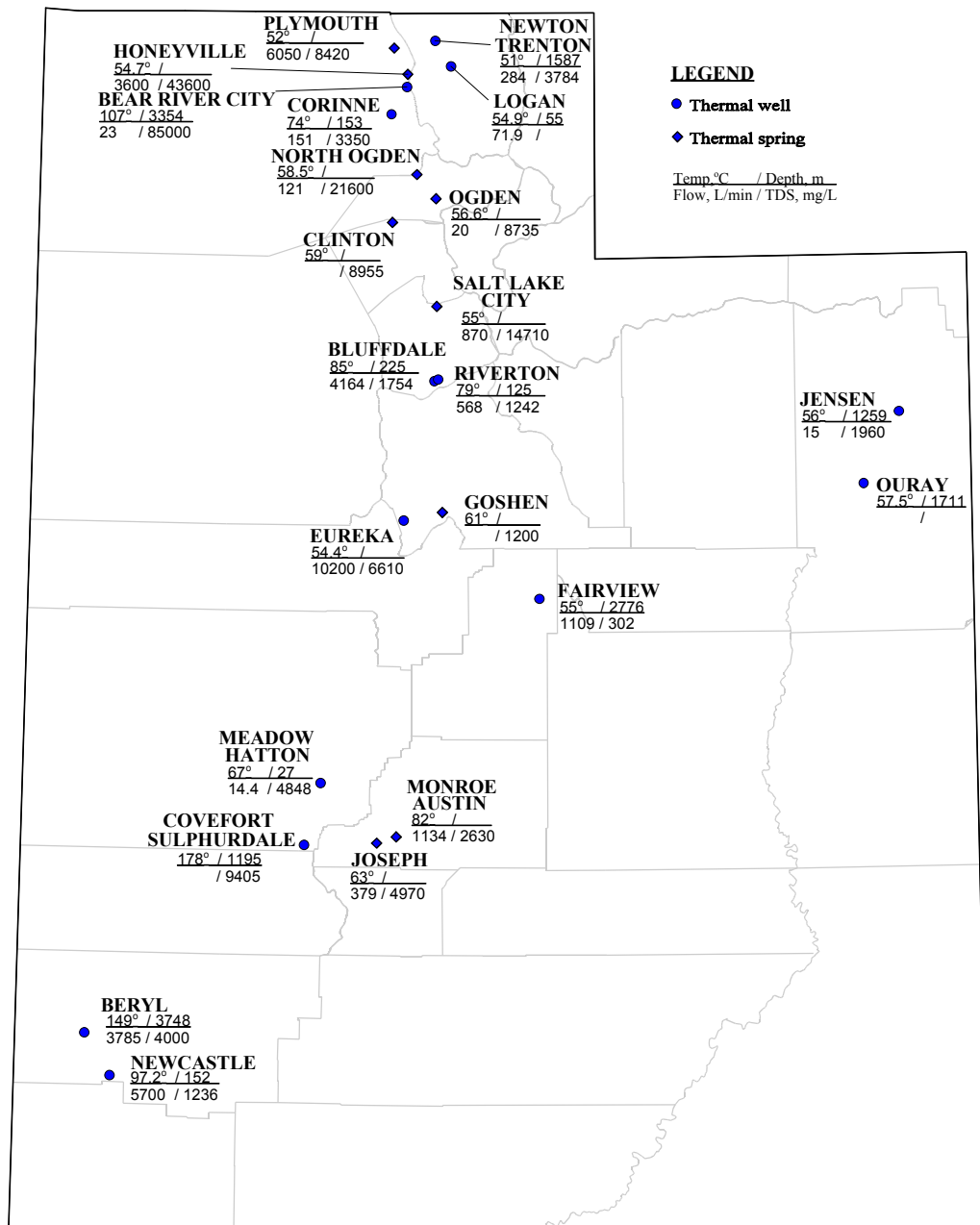

WASHINGTON COMMUNITIES WITH GEOTHERMAL RESOURCE DEVELOPMENT POTENTIAL

(Geothermal Resources with Temperatures > 50°C)

1995

T Boyd
Geo-Heat Center

EXPLANATION

The cities and towns of Washington shown on this map are located within 5 miles of a known geothermal resource that has a temperature greater than 50°C (122°F).

LEGEND

• Thermal well

◆ Thermal spring

Temp.°C / Depth_m
Flow, L/min / TDS, mg/L

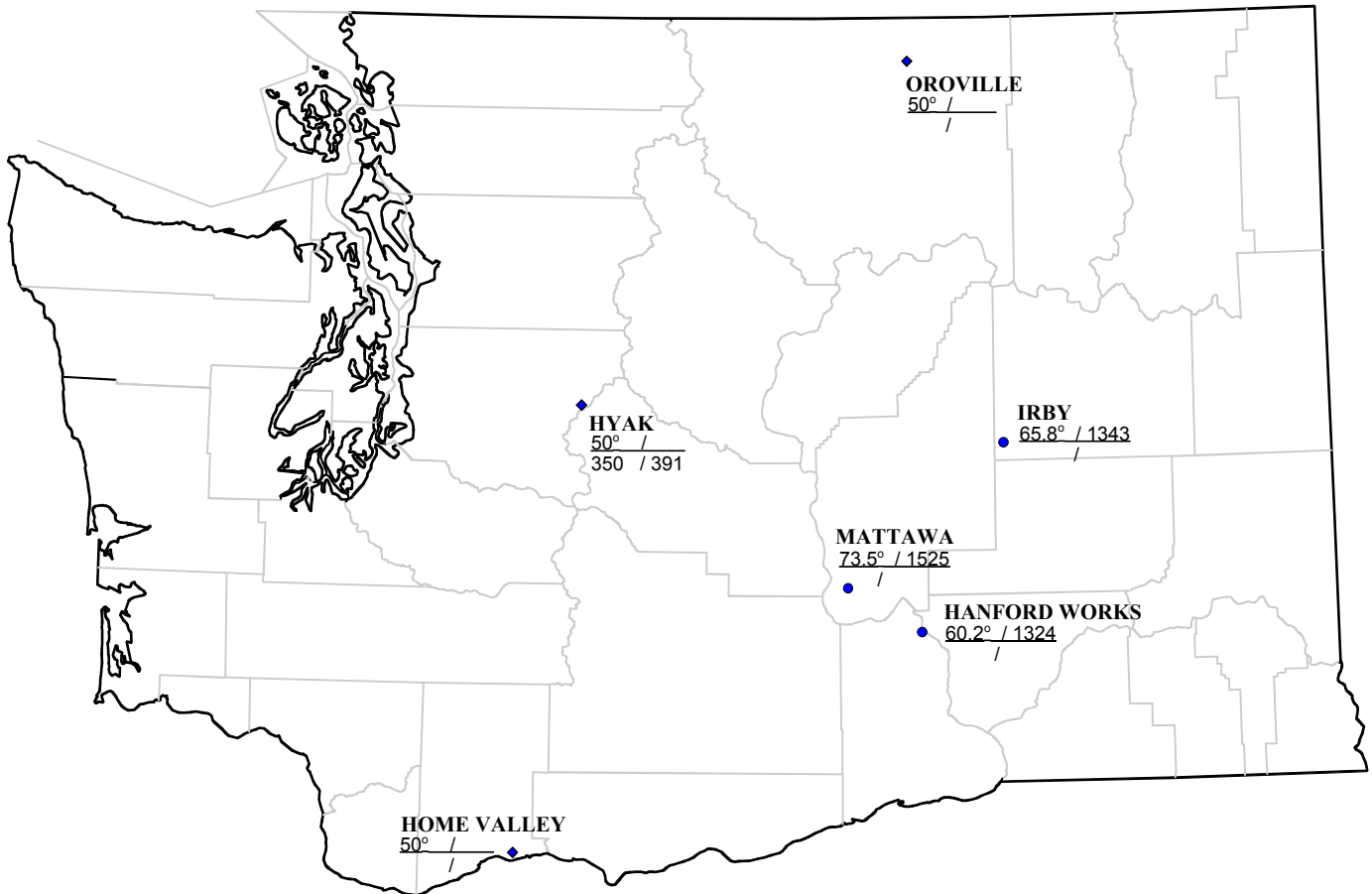

APPENDIX C

State Team Principal Investigators

STATE RESOURCE ASSESSMENT TEAMS

California

Leslie G. Youngs
Department of Conservation, MS08-38
Division of Mines and Geology
801 K Street
Sacramento, CA 95814-3531
Ph: (916) 322-8078
Fax: (916) 445-3334

Colorado

James A. Cappa
Colorado Geological Survey
Department of Natural Resources
715 State Centennial Building
1313 Sherman Street
Denver, CO 80203
Ph: (303) 866-2611
Fax: (303) 866-2461

Idaho

Leland L. Mink
John D. Kauffman
Idaho Water Resources Research Institute
Morrill Hall, Room 106
University of Idaho
Moscow, ID 83843
Ph: (208) 885-6429
Fax: (208) 885-6431

Montana

Wayne Van Voast
John Metesh
Montana Bureau of Mines and Geology
Montana College of Mineral Science & Technology
1300 West Park Street
Butte, MT 59701
Ph: (406) 496-4169
Fax: (406) 496-4451

New Mexico and Arizona

James C. Witcher
SWTDI
New Mexico State University
Box 30001, Dept. 3SOL
Las Cruces, NM 88003-0001
Ph: (505) 646-3949
Fax: (505) 646-2960

Nevada

Larry Garside
Nevada Bureau of Mines and Geology
University of Nevada, Reno
Mail Stop 178
Reno, NV 89557-0088
Ph: (702) 784-6691
Fax: (702) 784-1709

Oregon

George Priest
Gerald Black
Oregon Department of Geology and Mineral Industries
Suite 965
800 N.E. Oregon Street, #28
Portland, OR 97232
Ph: (503) 731-4100
Fax: (503) 731-4066

Utah

Robert E. Blakett
Department of Natural Resources
Utah Geological Survey
2363 South Foothill Drive
Salt Lake City, UT 84109-1491
Ph: (801) 467-4970
Fax: (801) 467-4070

Washington

Eric Schuster
Washington State Department of Natural Resources
Division of Geology and Earth Resources
P.O. Box 47007
Olympia, WA 98504-7007
Ph: (206) 902-1451
Fax: (206) 467-1785

Gordon Bloomquist
Washington State Energy Office
P.O. Box 43165
Olympia, WA 98504-3165
Ph: (360) 956-2016
Fax: (360) 956-2030

ESRI/University of Utah

Mike Wright
Howard Ross
Earth Sciences and Resources Institute
1515 E. Mineral Square, Room 109
Salt Lake City, UT 84112
Ph: (801) 581-5126
Fax: (801) 585-3540

Geo-Heat Center/Oregon Institute of Technology

Paul J. Lienau
Kevin Rafferty
Geo-Heat Center
Oregon Institute of Technology
3201 Campus Drive
Klamath Falls, OR 97601
Ph: (541) 885-1750
Fax: (541) 885-1754

DOE

Marshall Reed
U. S. Department of Energy
1000 Independence Avenue SW, CE-122
Washington, DC 20585
Ph: (202) 586-8076
Fax: (202) 586-8185

INEL

Joel Renner
Idaho National Engineering Lab.
P.O. Box 1625-3830
Idaho Falls, ID 83415
Ph: (208) 526-9824
Fax: (208) 526-0969