

MAGNETOTELLURIC SURVEY
of the
LEACH HOT SPRINGS AREA
of
NORTH CENTRAL NEVADA

for
SUNOCO ENERGY DEVELOPMENT CO.
12700 Park Central Plaza
Dallas, Texas 75251

GEOTRONICS CORPORATION
10317 McKalla Place
Austin, Texas 78758

Ken Owens, Geologist
David Halpin, Chief Geologist

October 1979

TABLE OF CONTENTS

<u>Section</u>	<u>Page No.</u>
I. Summary	I-1
II. Introduction	II-1
III. Interpretation	III-1
IV. Discussion	IV-1
V. Conclusions and Recommendations	V-1
VI. Selected References	VI-1

LIST OF FIGURES

	<u>Following Page No.</u>
Figure 1 - Model A, Conductive Surface Block	IV-1
Figure 2 - Apparent Resistivity Curves	IV-1
Figure 3 - Type Model; Buried Conductive Dike	IV-3

LIST OF PLATES

Plate 1	Site Location Map
Plate 2.1	Plan-View Resistivity Distribution at -4000 Feet
Plate 2.2	Plan-View Resistivity Distribution at -12,000 Feet
Plate 3	Tensor Rotation Angle and Magnetic Field Dip Azimuth
Plates 4A thru 4G	Resistivity Cross Sections (RTE) and Dip-Axis Directions (Ayz)
Plates 5A thru 5G	Resistivity Cross Sections (RTM)
Plates 6A thru 6G	Correlation Cross Sections, Log-Log (RTM & RTE)
Plates 7A thru 7G	Correlation Cross Sections, Log-Linear (RTM)
Plates 8A thru 8G	Correlation Cross Sections, Log-Linear (RTE)
Plates 9A thru 9G	Anisotropy Factor Cross Sections
Plates 10A thru 10G	Anisotropy Sense Cross Sections

I. Summary

A magnetotelluric survey was conducted for Sunoco Energy Development Co. around the known geothermal resource area at Leach Hot Springs in Grass Valley, Nevada. The objective of the survey was to investigate the subsurface and examine the electrical properties of the rocks. The specific objective was to attempt to define the potential geothermal source and reservoir. A shallow conductive layer found beneath most sites is thought to be a hot water zone associated with the surface springs. At depth along the east side of the valley, a conductive anomaly is interpreted to be a channel to the heat source. The most potentially prospective part of this elongated anomaly occurs near the southeast edge of the survey area. Resistive anomalies seen at intermediate depth beneath several sites near the center of the valley are interpreted to be fault blocks. Around these blocks appear possible structural and stratigraphic traps that may be prospective should hydrocarbons be found to exist within this environment.

II. Introduction

In April and May 1979, Geotronics Corporation performed a magnetotelluric (MT) survey for Sunoco Energy Development Co. in Grass Valley of north-central Nevada. Thirty-nine MT sites were recorded in the vicinity of Leach Hot Springs, a known geothermal resource area, 26 miles south of Winnemucca, Nevada. Site locations and traverse lines are shown on Plate 1. Site spacing is in a grid pattern of approximately one mile. Sunedco is one of the leaders in recognizing the necessity of close-grid site spacing in the complex resistivities involved in geothermal exploration.

Grass Valley is near the center of the Battle Mountain high heat flow region, which is nearly 100 miles in diameter. Grass Valley is a typical graben of the Basin and Range Province. The valley is about 30 miles long, north to south, and eight miles wide. It is bounded by the Sonoma Range on the east, the East Range on the west, and constricted to the south by the Goldbank Hills. These mountains are composed of rocks from early Paleozoic to Cenozoic age. The rocks are highly folded, faulted, and thrust. Tertiary andesites and rhyolites are extensive in the Sonoma Range. Quaternary silt, sand, and gravel cover the valley floor and obscure the geology below.

Near the southeast end of the valley lies Leach Hot Springs with surface temperature of about 200° F (above boiling at this altitude). Reservoir temperature at depth is estimated as high as 338° F. The springs occur at a fault with a scarp 30 feet high. Recharge for the springs is thought to come from run off in the Sonoma Range by means of fractures and faults.

The objective of the MT survey was to examine the electrical properties of the subsurface and specifically to attempt to define the present day geothermal heat source and reservoir. Data were recorded from 254 to 0.001 Hertz. Data quality was good

throughout the survey area, cultural noise being minimal. However, many sites had some scatter of data, mostly in the mid-frequency range on the minimum component of apparent resistivity. Advanced procedures were utilized in data processing. In addition to the wide-band averaging technique, Geotronics recently innovated automatic machine smoothing of the apparent resistivity data.

The objectives of the survey were met and several definitive features were identified in the subsurface having both vertical and lateral extent. MT has proved to be a reliable and cost-effective tool in the Basin and Range environment. Similar to other geophysical techniques MT data interpretation consists of observation and deduction.

Basic Observation

The magnetotelluric basic observations are the frequency domain impedance functions which are derived objectively and directly from the field measurements at each site. These are unique functions of the subsurface geoelectrical properties alone. Inversely, the magnetotelluric impedance functions uniquely define the geoelectrical structure for a very wide range of possible subsurface configurations.

Interpretation

The interpretation is subdivided into two stages:
(1) electrical and (2) geological.

The electrical interpretation stage determines, from the basic observations, the nature and distribution of the subsurface conductivities. Ideally this interpretation is unique and totally objective. However, in practice some uncertainties exist, since the resolution is bounded due to finite sampling and accuracy of the data.

The geological interpretation stage derives a lithological, structural, and stratigraphical concept from the electrical conductivity structure. Naturally the geological interpretation employs a number of subjective approaches. These include use of:

1. Joint inference between the magnetotelluric and other independent geophysical information.
2. Available geological information about the area.
3. Experience in the general geological-geophysical style of the area.

The final interpretation is thus derived so that it is consistent with the magnetotelluric data and with other known observations.

III. Interpretation

The interpretation of this magnetotelluric survey has produced conclusions of possible exploration significance. The following principal features are deduced from all of the MT data in general, and specifically as discussed in the next section.

1. A shallow conductive layer found beneath most sites is thought to be a hot water zone associated with the surface springs by fault and fracture conduits. This layer has the configuration of a discrete sedimentary unit; thinning and shallower near the margins of the valley. The layer is about 2,000 feet thick and occurs within the upper 4,000 feet of section.

2. Buried resistive features in the center of the valley resemble fault blocks and appear to be a northward extension of the Goldbank Hills.

3. Possible structural and stratigraphic traps appear around the buried fault blocks. Should hydrocarbons be found to exist within this high heat environment, structural traps should be expected above the fault blocks and against their sides while stratigraphic traps would be expected at intermediate depths around the shoulders of the blocks.

4. Major normal fault traces related to the resistive blocks and outcrops are interpreted sub-parallel to the axis of the valley.

5. A conductive anomaly occurs at depth beneath most of the sites along the frontal fault on the east side of the valley. The anomaly is interpreted to be associated with the heat source for the geothermal system. This heat source is probably an intrusive in the form of a dike. Run-off water from the mountains descends along fractures and faults, becomes heated at depth, and ascends to the surface. Depth to the apparent heat source is about 26,000 feet. The most prospective part of this anomaly is in the vicinity of sites 29 and 35.

The importance of the deep anomaly warrants additional study using all geological and geophysical means available to define potential prospects. Additional MT sites may be deemed necessary. Some study must also be reserved for the shallow layer especially in the vicinity of Leach Hot Springs.

IV. Discussion

The information contained in this section of the report is primarily a description and discussion of the various quantities computed from the magnetotelluric data recorded in the field. The interpretation of these results in terms of the postulated geophysical and geological characteristics of the subsurface has been presented in the preceeding section of this report.

Depths listed in this report are the results of the Bostick one-dimensional inversion procedure. To interpret and adjust depths, due to the two-dimensional character of the area, would require bore-hole or geophysical tie information or adjustments based on model studies.

A. Apparent Resistivity/Frequency Curves

Grass Valley, which contains Leach Hot Springs, is a Basin and Range structural environment. This structural environment, and therefore the data response, closely matches the style of the two-dimensional model, Conductive Surface Block, shown in Figure 1. The model is one of a series originated in 1970 by Geotronics personnel. The particular two-dimensional model under consideration consists of a conductive valley of 10 ohm-meter material 20 kilometers wide and 2 kilometers deep surrounded by a 1,000 ohm-meter basement matrix. The object of the valley model was to study high resistivity contrast between resistive and conductive units and the presence of vertical resistor-conductor contacts brought to or near the surface.

Figure 2 shows part of the model results presented as apparent resistivity versus frequency curves for four nodes (surface locations) on either side of the resistor-conductor contact. Two of the nodes are adjacent to the vertical contact and the other two are distant from it. The arrows call attention to the 100 ohm-meter center-line. On the conductive side of the contact, within the valley,

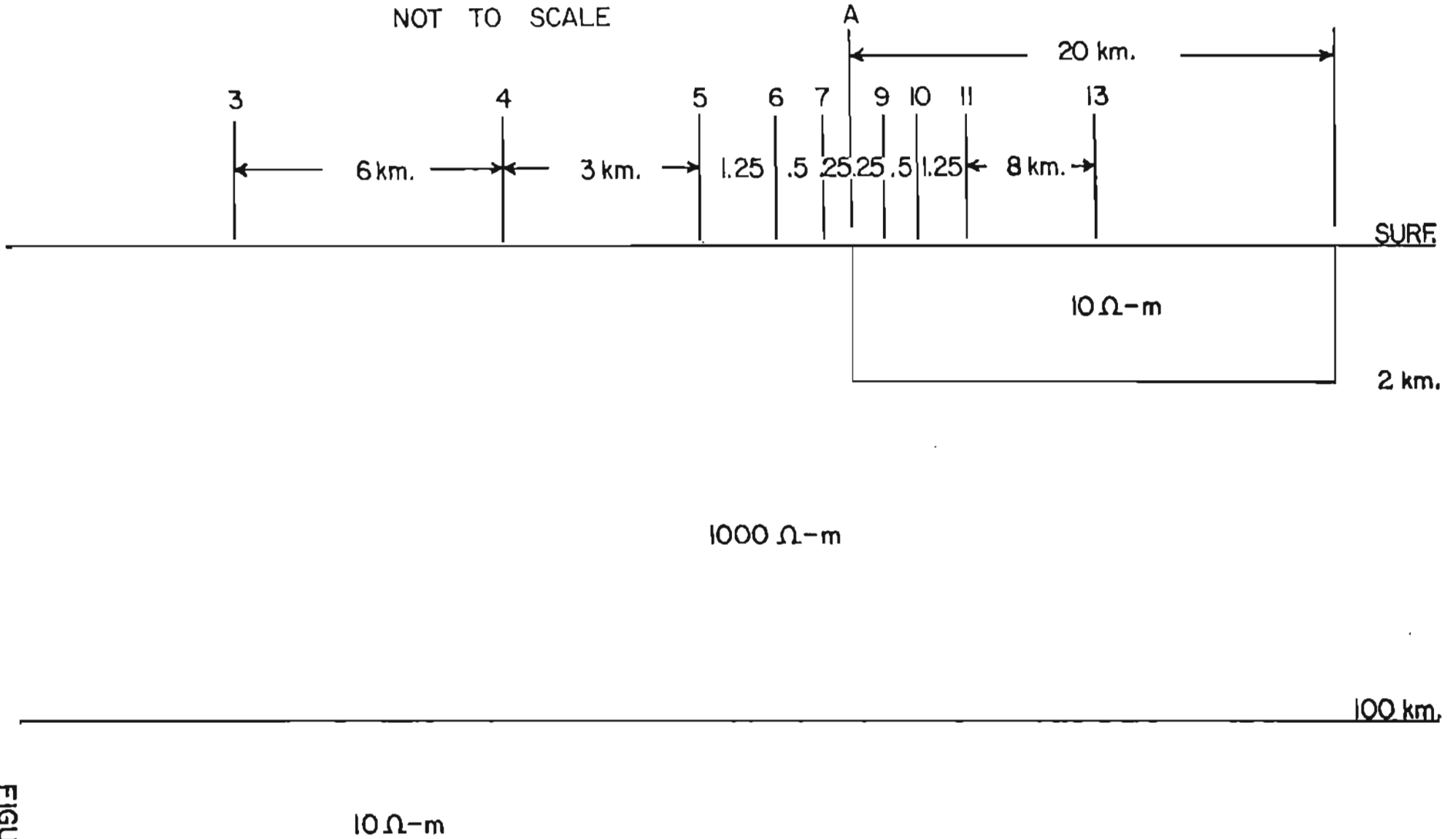

FIGURE 1

MODEL A
CONDUCTIVE SURFACE BLOCK

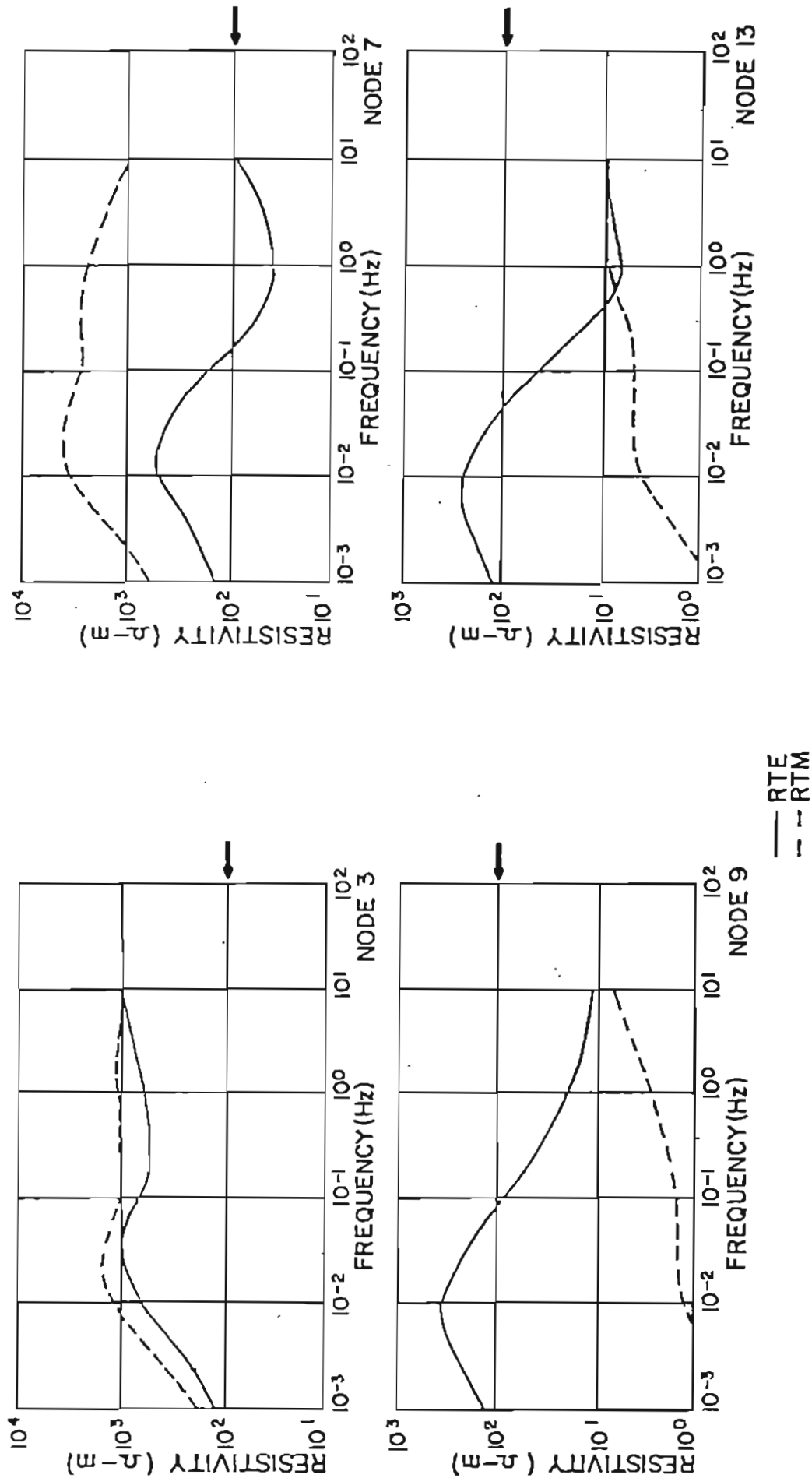

FIGURE 2

© 1970 GEOTRONICS CORPORATION

APPARENT RESISTIVITY
 VERSUS FREQUENCY
 NODES 3 7 9 13

the RTE (E-parallel to strike) component approximates the one-dimensional earth solution. The RTM (E-perpendicular to strike) component, with extremely low resistivities at the lower frequencies, bears no resemblance to the actual configuration beneath the site (node). Nodes 9 and 13 show the characteristic anisotropy; greatest close to the contact and decreasing only slightly in the center of the valley.

Nodes 3 and 7 are representative of data on the resistive side of the contact. Characteristically the RTM component exhibits an "overshoot", with apparent resistivity values higher than those of the materials present in the model. The RTE component, on the other hand, exhibits a smooth transition from conductive to resistive side, and thus in the vicinity of the contact exhibits an "undershoot". As the observer moves away from the contact both TM and TE curves approach the one-dimensional earth curve. For node 7 it is seen that anisotropy is large. It is observed that the TM inversion although exhibiting the resistive "overshoot" will give the more acceptable exploration solution in the immediate vicinity of the contact since the TE component could be interpreted in terms of a subsurface conductor which does not exist.

The following is a discussion of features of the apparent resistivity versus frequency curves for the survey as found on page 1 of the X-Y plots, and submitted to Sunedco as part of the support data package. These curves may be directly compared with the model data. The curves are best examined by arranging the sites in sequence and studying the changes that occur from site-to-site along each traverse, using the model study as a guide. Pages should be viewed with apparent resistivity scale on the left margin and 10 ohm-meters aligned horizontally.

Visually, most of the curve-pairs appear related to model nodes on the conductive side of the vertical barrier. For these clear cases the maximum curve is designated E-parallel (RTE), leaving the lower curve as E-perpendicular (RTM). Conversely, sites 9 and 36 are related to model nodes on the resistive side of the vertical barrier. For these two sites the minimum curve is RTE data. Sites 25, 31, 32, and 33 also have the minimum curve designated RTE, based on resistivity comparison with site 36. Sites 6, 8, 14, 24, and 30 show increased resistivity contrasts with adjacent sites, especially at high frequency. For these sites, the minimum curve is designated RTE; and further study shows that they compare with the Conductive Dike Model, Figure 3. This model is a representation for a fractured or intrusive geothermal anomaly where this feature emanates from a conductive magmatic basement. The main effect of the 'dike' is the conductive pull-down on the RTE (minimum) component at mid-frequencies. It is evident that the RTM component does not detect the localized 'dike' and remains unchanged across this model. The RTE component reacts very strongly to the conductive 'dike'. The strongest response covers about two diameters over the 'dike' and the effect is evidenced some distance laterally. The implication here is that if a conductive 'dike' has been correctly interpreted, the apparent conductive downturn of the RTE will be considered as a lateral indicator as well as a vertical one. Based on anisotropy, the 'dike' could be erroneously determined to be more than twice as wide as it actually is. Furthermore, in a real setting, location of the body could not be determined without closely spaced recording sites. One-dimensional inversions of the modeled RTE data indicate depths to the conductive 'dike' of 8000' over the 'dike', an apparent depth of 18,000' at approximately 2.5 miles laterally from this feature, and an apparent depth of 30,000 feet at approximately 8 miles laterally from the 'dike'. These data, therefore, indicate that

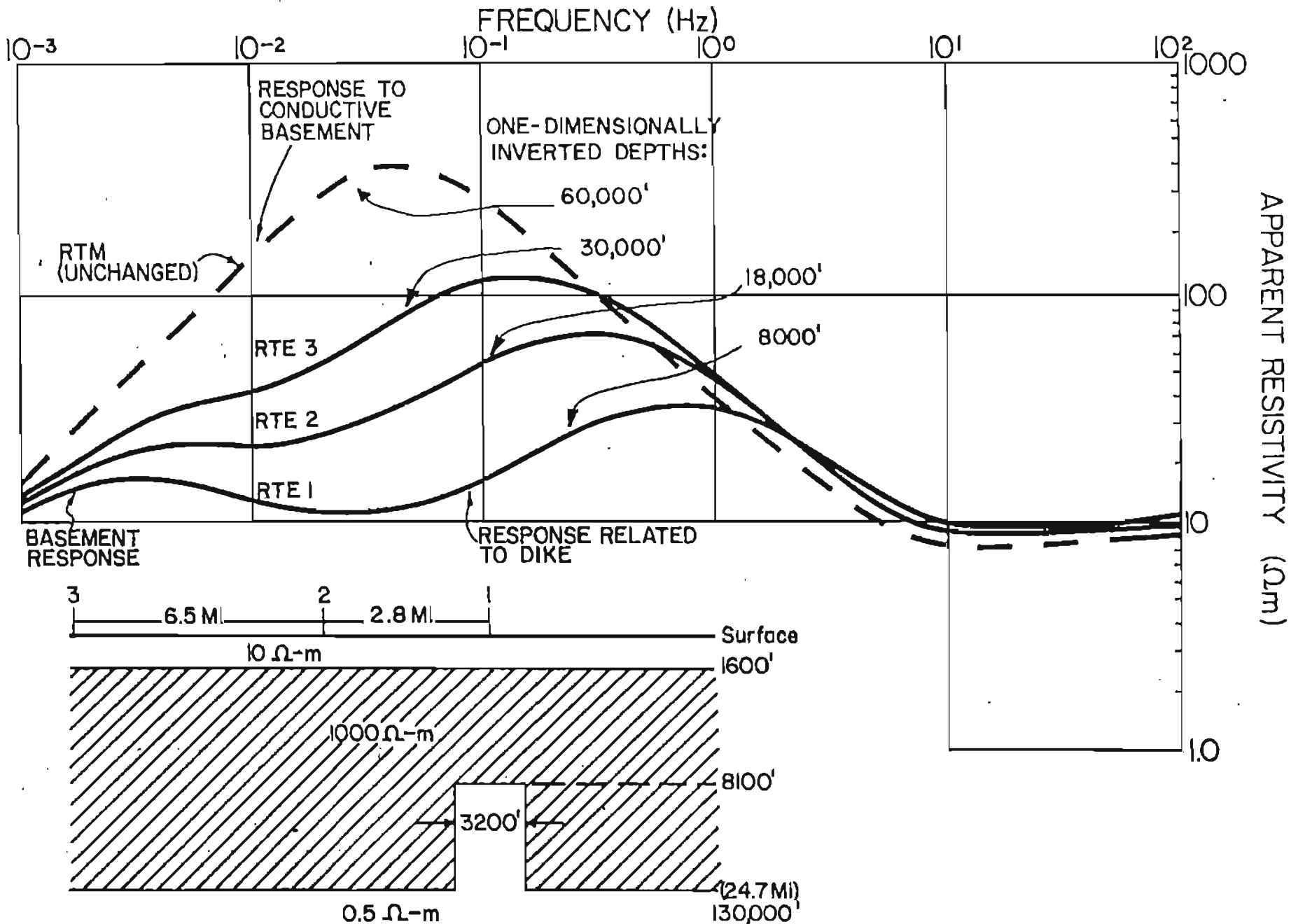

FIGURE 3

© 1978 GEOTRONICS CORPORATION

TYPE MODEL
BURIED CONDUCTIVE (GEOTHERMAL) DIKE

many of the conductive features recognized on the data displays may be more localized along fault and fracture zones than is portrayed.

Sites 26, 38, and 39 are borderline cases and the rotation angle was the final determining factor in designating the maximum curve RTE.

Generally speaking, sites in the northern and western portion of the survey exhibit appreciably lower apparent resistivity than those to the south. This contrast seems to propose an east-west cross feature through the middle of Township 31 North, extending from Panther Canyon westward across the north end of Goldbank Hills. The relationship with other evidence, topography, gravity, etc., is vague.

Sites 29 and 35 exhibit low anisotropy coupled with low resistivity. This appears significant in light of geothermal indications of the conductive anomalies on the contoured resistivity cross sections. Sites 1 and 10 also have low anisotropy and low resistivities; but the interpretation is that these sites are located near the center of the valley, removed from the effect of the vertical conductive-resistive barriers and with thick conductive sections.

Site 17 appears to exhibit non-minimum phase behavior of the RTM component at low frequency (See: apparent resistivity plot of MAGTAN output). The condition exhibited is thought to be the result of extreme resistivity contrast between the two components, and one which is often interpreted as indicating a geothermal anomaly.

B. Resistivity Distribution Maps

Plates 2.1 and 2.2 are the contoured resistivity distribution maps at -4,000 and -12,000 feet, respectively. The foundation for these presentations are the contoured resistivity cross sections of the one-dimensional inversions, RTE component. The

RTE component has proved to be more reliable as a depth and resistivity indicator than the RTM in this type of environment. Depth adjustments based on the degree of anisotropy were not incorporated into this report.

Within the valley proper, several sites indicate highly resistive anomalies. Based on the known conditions near site 4, the interpretation is that these anomalies are buried fault blocks.

The shallow conductive anomaly in the vicinity of sites 1, 2, and 10 is interpreted to be valley fill.

On both the intermediate and deep maps, a conductive anomaly occurs in the area of sites 29 and 35. This anomaly needs further study. There is also an indicated conductive anomaly near site 8; and resistivity generally decreases at all sites near the mountain front on both maps.

C. Tensor Rotation Angle and Magnetic Field Dip Azimuth

Plate 3 displays in plan view the tensor rotation angle $A(z)$ of the RTE component at low frequency and the magnetic field dip azimuth $A(kz)$ for each site. (Please note: The declination angle of 17.5° must be added to the data shown on page 3 of the X-Y plots.) The data on Plate 3 have been corrected. The rotation angle is shown as a line through the site with the bearing listed adjacent. Consistent alignment on a site-to-site basis shows the electrical axis of the valley about $N 45^\circ W$ (135°). The magnetic field dip azimuth for each site is shown as an arrow. Questionable data are shown as dotted arrows. Dip-axes vary from NNW to NE and contain 180° ambiguity with regard to geologic dip.

The relationship between the two azimuths is considered good when the angle between the two approaches 90° . Acute angles result from multi-dimensional effects.

D. Resistivity Cross Sections

Plates 4A through 5G portray the contoured resistivity cross sections based on one-dimensional inversions. The dip-axis directions A(yz) are shown above the sites on the RTE sections. It is on the RTE component that most of the interpretation is based since the RTE component has proved most reliable as to depth and stratigraphic correlations.

General features observed on the contoured resistivity cross sections are:

1. A thin resistive unit occurs near the surface at many sites within the valley.
2. A very conductive layer is seen at most sites within the valley. This unit is about 2,000 feet thick and varies slightly within the upper 4,000 feet of section. Near the edges of the valley and over structural highs, the unit thins and shallows.
3. Large highly resistive anomalies are seen about sea level on each of the traverse lines. Most of the anomalies appear to be vertical features.
4. Vertical contours occur between several of the sites. Vertical contours are generally indicators of rapid lateral changes, i. e. faults, and together with other evidence have been so interpreted. Approximate locations of the indicated faults are shown on the correlation cross sections, (Plates 6A through 8G).
5. Conductive anomalies occur at depth beneath sites 6, 8, 12, 14, 24, and 29. All of these sites except site 12 are along the frontal fault zone.

E. Electrical Dip-Axis Directions A(yz) as shown in polar-plot above each site contain 180° ambiguity with regard to geologic dip. The data are consistent and tight, indicating very little scatter in preferred orientation. These dip directions correctly include the declination angle of 17.5° . Based on the automatic mode selection, the dip direction is independently plotted to coincide with the RTM component. In the presence of multi-dimensional influences, the automatic RTM/RTE mode selection can be erratic. Therefore for interpretive purposes, a 90° alternate mode selection was chosen at those sites previously discussed. The resultant dip directions vary from ESE-WNW to NE-SW and are in moderate agreement with electrical strike.

F. Correlation Cross Sections

Plates 6A through 8G display the correlation cross sections based on one-dimensional inversion. Both logarithmic and linear depth scales were used in preparing and displaying the correlation data. In correlating data, emphasis was placed on tracking the principal features observed in the area on a site-by-site basis. Every resistive or conductive anomaly on the inversion curve represents a potential horizon to trace. The lines of correlation were picked at the inflection points of the inverted data, as opposed to the resistivity maxima or minima. Discontinuous correlations can be due to truncation by faulting, erosion, or non-deposition; or by a change in bulk resistivity characteristics due to changes in porosity, lithology, or geothermal gradient.

The resistivity data as presented on the correlation plate may be viewed as analogous to a smoothed electric log where the volume influencing the resistivity value increases as an exponential function of depth. While this analogy must be used with caution (especially in areas of three-dimensional complexity), the insight gained concerning the

subsurface characteristics of an area by studying the correlations data is similar to that which would be based on a bore-hole log correlation. The center-line of each site represents ten ohm-meters resistivity, and the horizontal deflection scale is logarithmic.

Correlations were carried through for the top and bottom of a near surface conductive zone, resistive basement at shallow to intermediate depth, and conductive basement at great depth. Faults shown have been interpreted from these sections and other data. Structural highs are indicated below sites 4, 13, 23, 28, and on and near the outcrops. Conductive basement is so deep that it is seen on the log-linear sections only at a few sites.

G. Anisotropy Factor and Anisotropy Sense Cross Sections

Plates 9A through 10G illustrate two-dimensionality data, anisotropy (literally: unequal spreading). The anisotropy factor cross sections are the contoured difference between the two apparent resistivity curves at each site. As with the resistivity sections, vertical contours between sites are frequently an indicator of vertical resistive boundaries (barriers), sometimes due to faults. Such interpreted data have been incorporated on the correlation plates.

Anisotropy sense is the rate of change, or derivative, of the anisotropy factor. The contoured anisotropy sense is principally used to delineate electrical features. Features of positive contrast are interpreted as resistive anomalies. Negative features are interpreted as conductive anomalies, while lack of anomalies results from one-dimensionality. Near surface lateral conductive anomalies relate to the conductive valleys.

V. Conclusions and Recommendations

As a result of this MT survey, several anomalies have been identified and further exploration efforts are warranted. The most prospective potential anomaly is in the vicinity of sites 29 and 35. No additional MT sites are recommended to define this feature. The elongated intermediate to deep conductive anomaly along the frontal fault of the Sonoma Range needs further MT sites to delineate its eastern edge. Also additional MT sites are recommended around site 8 to attempt to define the conductive anomaly there. Finally, some study must be made on the potential of the shallow conductive layer as a hot water reservoir in the vicinity of Leach Hot Springs.

VI. Selected References

- Beyer, H., et al, 1976, Geological and Geophysical Studies in Grass Valley, Nevada, University of California/Berkeley, Preliminary Open File Report, LBL 5262.
- Beyer, J. H., 1977, Telluric and D. C. Resistivity Techniques Applied to the Geophysical Investigation of Basin and Range Geothermal Systems, Part III: The Analysis of Data from Grass Valley, Nevada, University of California/Berkeley, LBL 6325 3/3.
- Dickinson, W. R., and Snyder, W. S., 1978, Plate Tectonics of the Laramide Orogeny, Geological Society of America, Memoir 151, p. 355.
- Ferguson, H. G., et al, 1951, Geology of the Winnemucca Quadrangle, Nevada, U. S. G. S., Map GQ-11.
- Geology of Nevada, Nevada Bureau of Mines, Bull. No. 65, 1964.
- Kamen-Kaye, Maurice, Paleozoic Strata of the Great Basin Province, The Oil and Gas Journal, January 2, 1978, p. 116.
- Keller, G. V., and Grose, L. T., 1978, Studies of a Geothermal System in Northwestern Nevada, Colorado School of Mines Quarterly, July, Vol. 73, No. 3, 84 pages.
- Liaw, A. L., 1977, Microseisms in Geothermal Exploration: Studies in Grass Valley, Nevada, University of California/Berkeley, LBL 7002.
- Majer, E. L., 1978, Seismological Investigations in Geothermal Regions, University of California/Berkeley, LBL 7054.
- Morrison, H. F., et al, 1979, Magnetotelluric Studies in Grass Valley, Nevada, University of California/Berkeley, LBL 8646.
- Roberts, R. J., et al, 1958, Paleozoic Rocks of North Central Nevada, A. A. P. G., Bull., V. 42, No. 12, p. 2813.

- Sass, J. H., et al, 1976, Geothermal Data from Test Wells Drilled in Grass Valley and Buffalo Valley, Nevada, University of California/Berkeley, LBL 4489.
- Speed, R. C., Basinal Terrane of the Early Mesozoic Marine Province of the Western Great Basin: in Mesozoic Paleogeography of the Western United States, Pacific Coast Paleogeography Symposium 2, S. E. P. M., April 1978, p. 237 - and - Paleogeographic and Plate Tectonic Evolution of the Early Mesozoic Marine Province of the Western Great Basin, p. 253.
- Stewart, John H., 1971, Basin and Range Structure: A System of Horsts and Grabens Produced by Deep-Seated Extension, Geological Society of America Bulletin, V. 82, p. 1019-1044.
- Stewart, John H., and Carlson, John E., 1977, Geologic Map of Nevada, and 1976, Cenozoic Rocks of Nevada, Nevada Bureau of Mines and Geology.
- Wollenberg, H., et al, 1977, Geochemical Studies at Four Northern Nevada Hot Springs Areas, University of California/Berkeley, LBL 6808.
- Word, D. R., et al, 1971, Crustal Investigation by the Magnetotelluric Tensor Impedance Method, Geophysical Monograph Series, American Geophysical Union, Vol. 14.
- Zietz, Isidore, et al, 1977, Aeromagnetic Map of Nevada, U. S. G. S., Map MF-902.

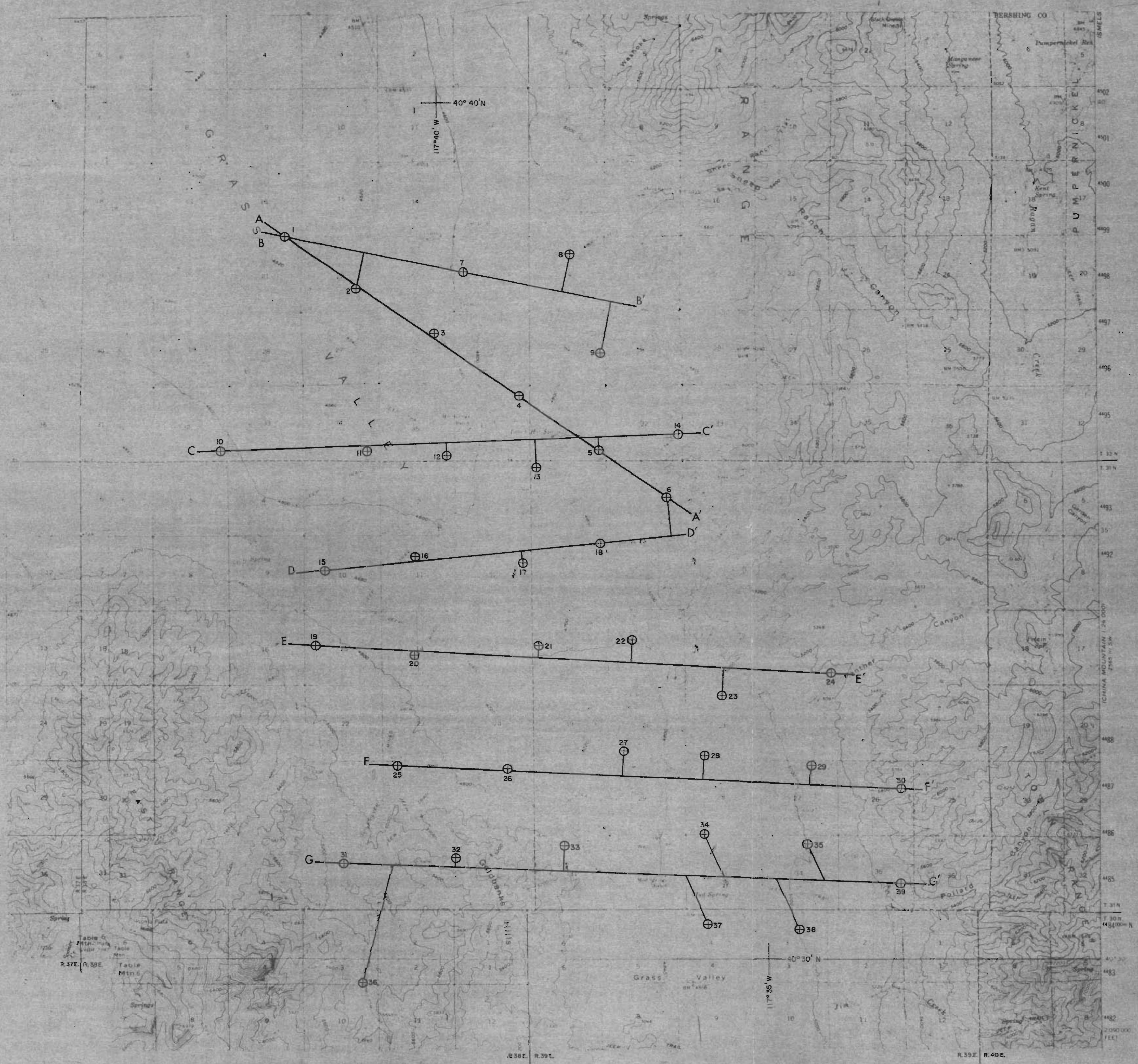

LEGEND

- ⊕ SITE LOCATION
- A LINE DESIGNATION
- 00 SITE NUMBER

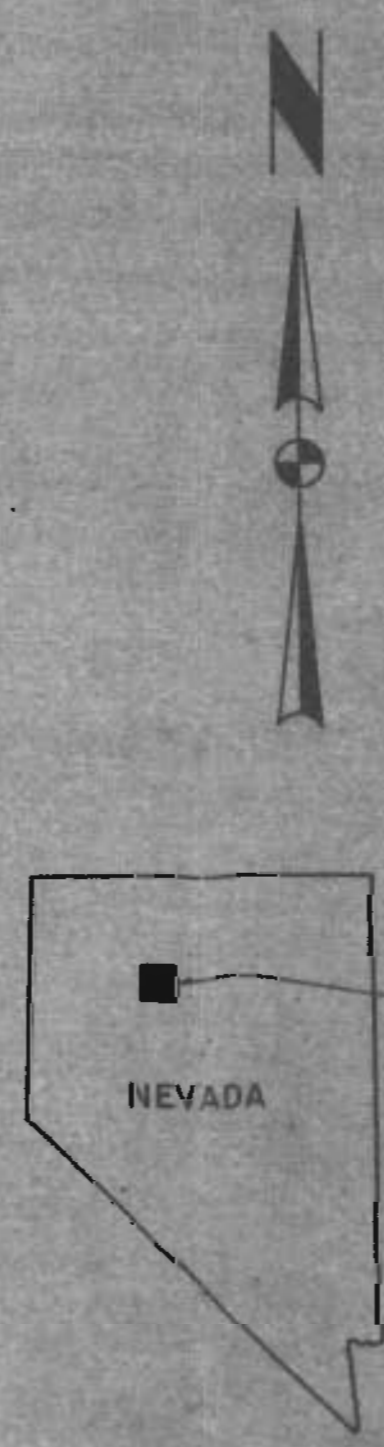
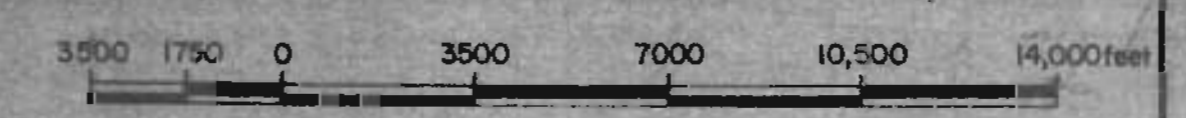

Geotronics Corp. Austin, Texas U.S.A.		SURVEY CODE	
MAGNETOTELLURIC SURVEY		199-SLS	
SUNEDCO-LEACH HOT SPRINGS		TITLE	
SITE LOCATION MAP			
DRAWN BY	<i>Tom Davis</i>	DATE	22 June 77
CHECKED BY	<i>R. Stevens</i>	DATE	24 June 77
APPROVED BY		DATE	
REVISIONS		No.	DATE

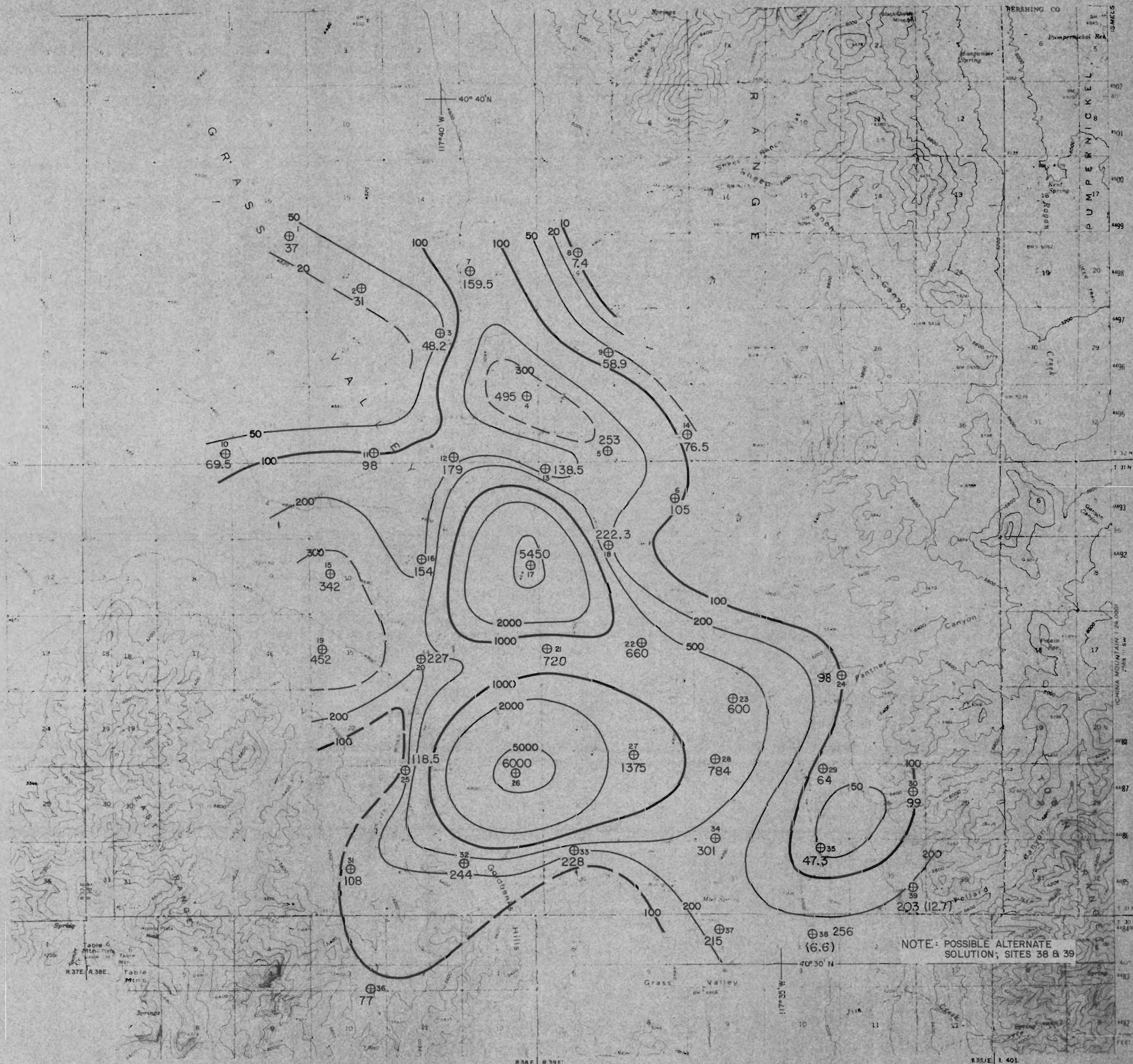

DATA TAKEN FROM RTE COMPONENT
 RESISTIVITY VALUES IN OHM-METERS
 CONTOUR INTERVAL = $1, 2, 5, \times 10^N$
 OHM-METERS WITH SUPPLEMENTARY
 CONTOURS
 BASE MAP: USGS TOPO.

⊕ SITE LOCATION
 00 SITE NUMBER

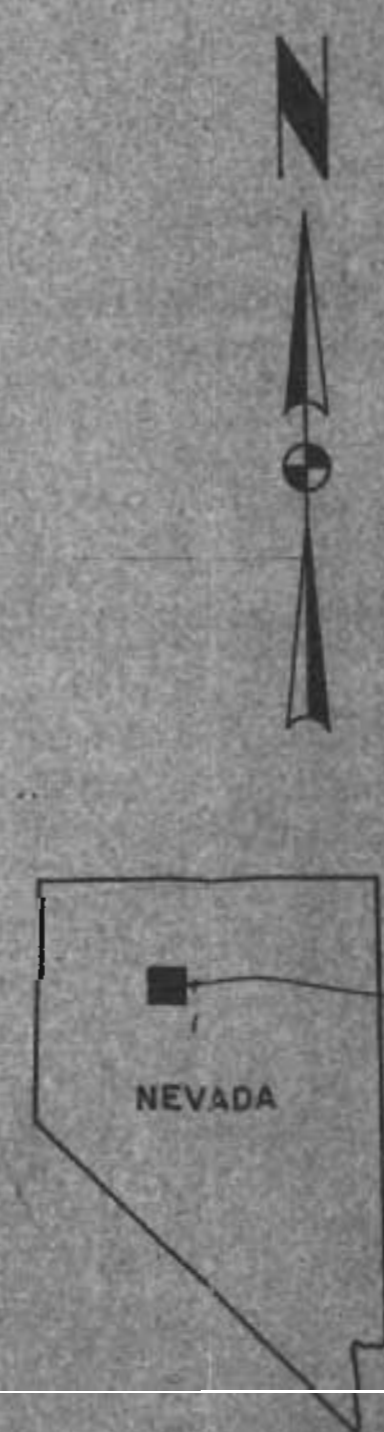
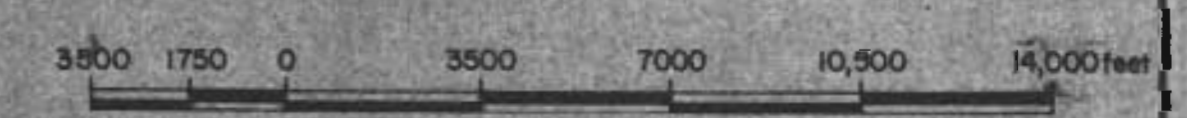

NOTE: POSSIBLE ALTERNATE SOLUTION; SITES 38 & 39

Geotronics Corp. Austin, Texas U.S.A.		SURVEY CODE	
MAGNETOTELLURIC SURVEY		199-SLS	
SUNEDCO-LEACH HOT SPRINGS		TITLE	
RESISTIVITY DISTRIBUTION AT-4000 FEET			
INTER. BY	<i>K. Stevens</i>	DATE	PLATE NO.
DRAWN BY	<i>M. H. ...</i>	DATE	2.1
CHECKED BY		DATE	
REVISIONS		No.	DATE

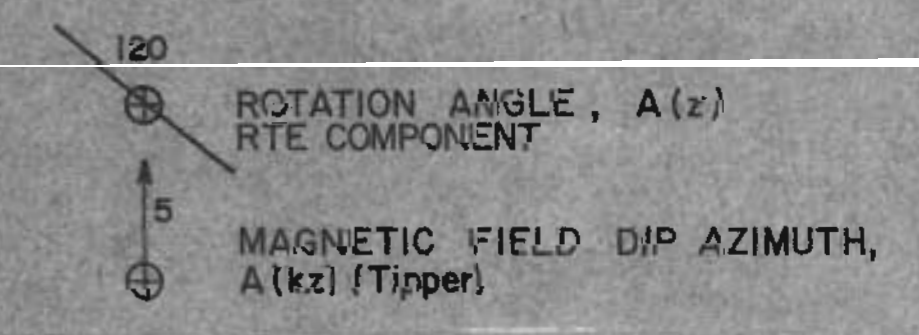
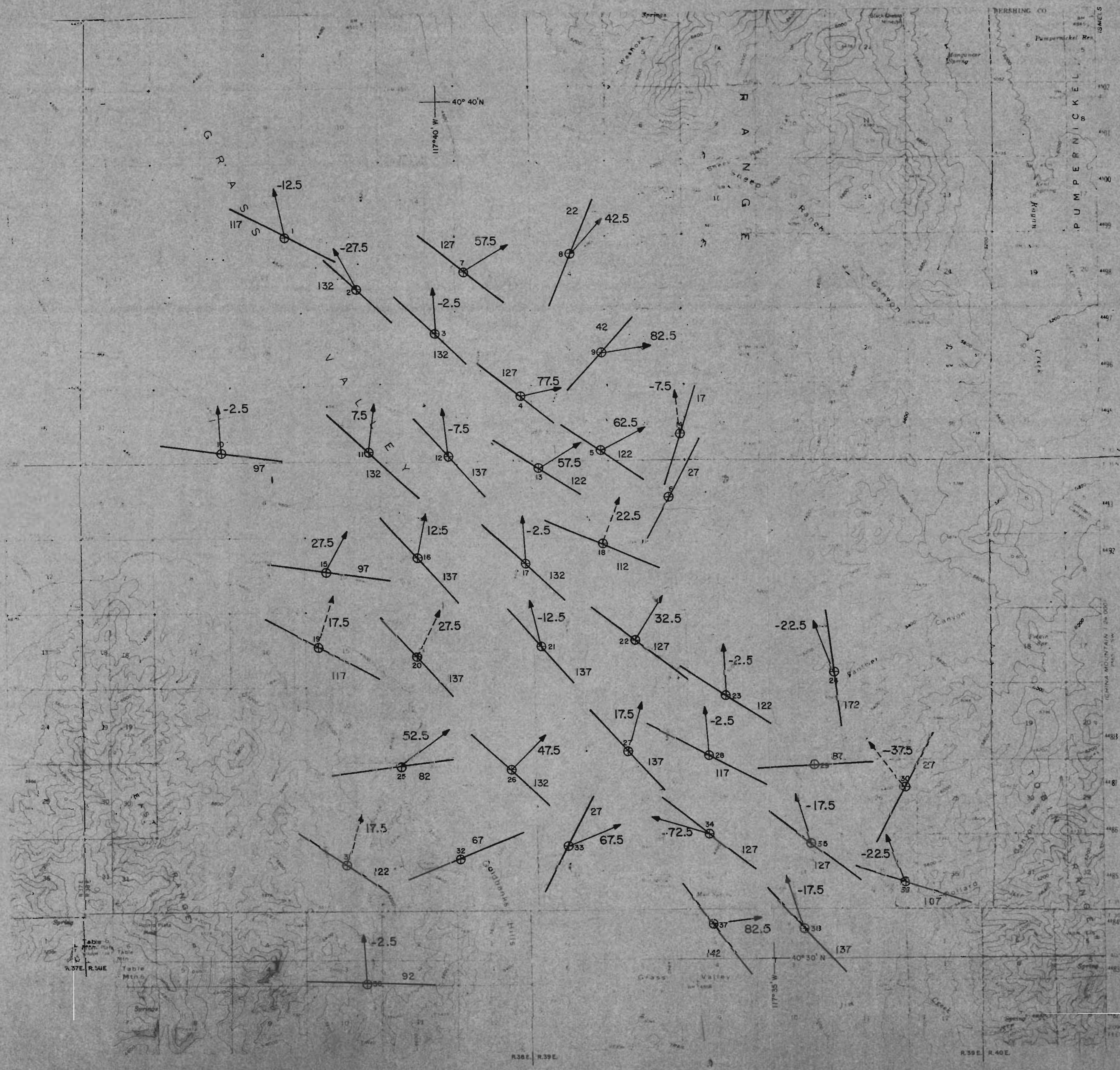

NOTE: DECLINATION OF 17.5° HAS BEEN ADDED TO DATA FROM PG. 3 OF X-Y PLOTS

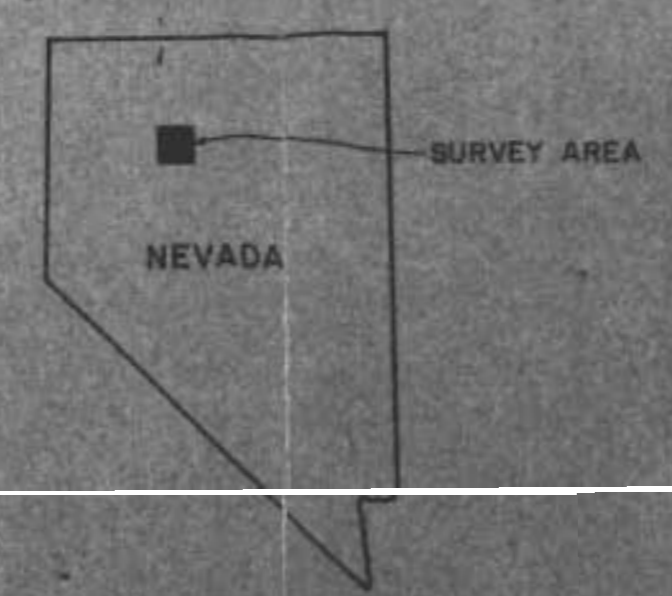
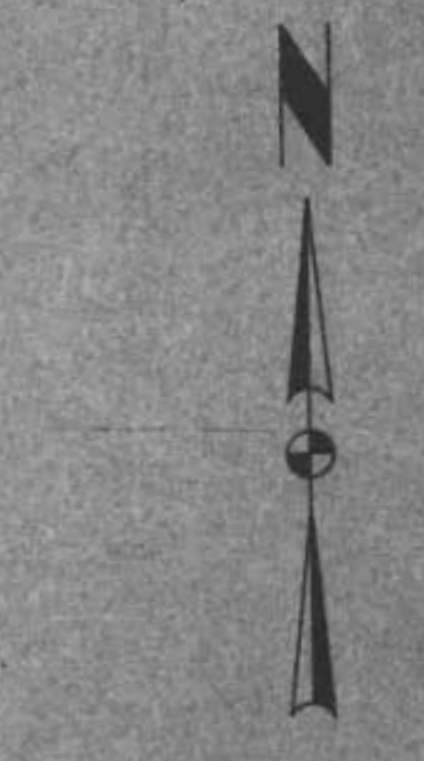
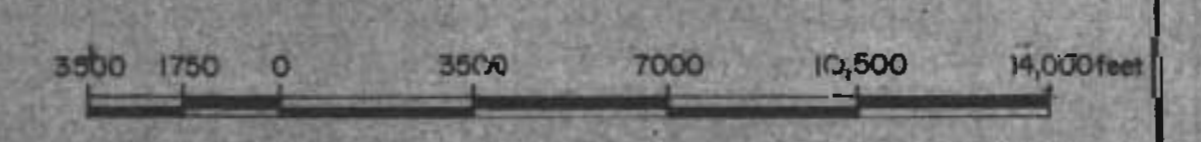
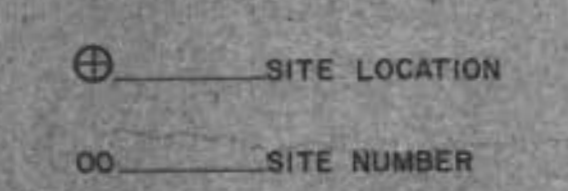

Geotronics Corp.			
Austin, Texas U.S.A.			
MAGNETOTELLURIC SURVEY			SURVEY CODE
SUNEDCO-LEACH HOT SPRINGS			Y99-SLS
TITLE			
TENSOR ROTATION ANGLE AND MAGNETIC FIELD DIP AZIMUTH			
INTER. BY	<i>Adams</i>	DATE	PLATE NO.
DRAWN BY	<i>McNeil & Company</i>	DATE	3
CHECKED BY		DATE	
APPROVED BY		DATE	
REVISIONS			No. DATE

A
NORTHWEST

A'
SOUTHEAST

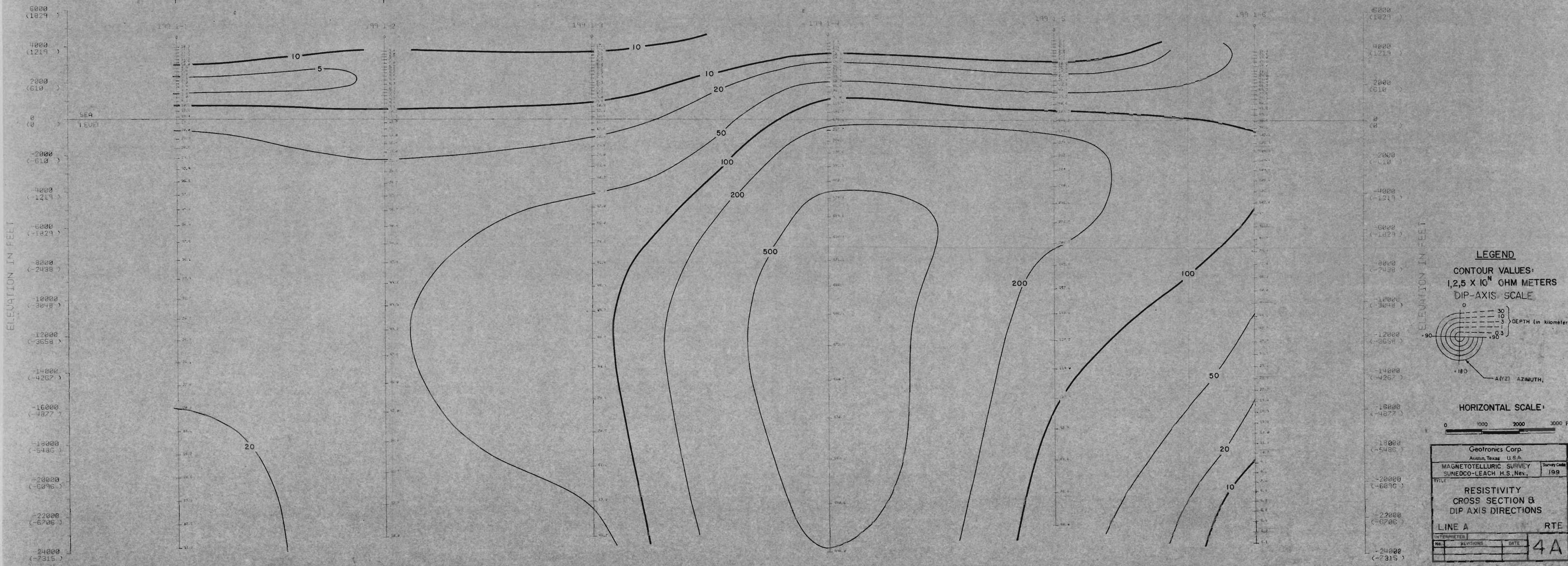

LEGEND

CONTOUR VALUES:
 $1, 2, 5 \times 10^N$ OHM METERS

DIP-AXIS SCALE

DEPTH (in kilometers)

AZIMUTH

HORIZONTAL SCALE:

Geofronics Corp. Austin, Texas U.S.A.		
MAGNETOTELLURIC SURVEY	Survey Code	199
SUNEDCO-LEACH H.S., Nev.		
TITLE		
RESISTIVITY CROSS SECTION & DIP AXIS DIRECTIONS		
LINE A	RTE	
INTERPRETER	DATE	4A
No.	REVISIONS	

B
WEST

B'
EAST

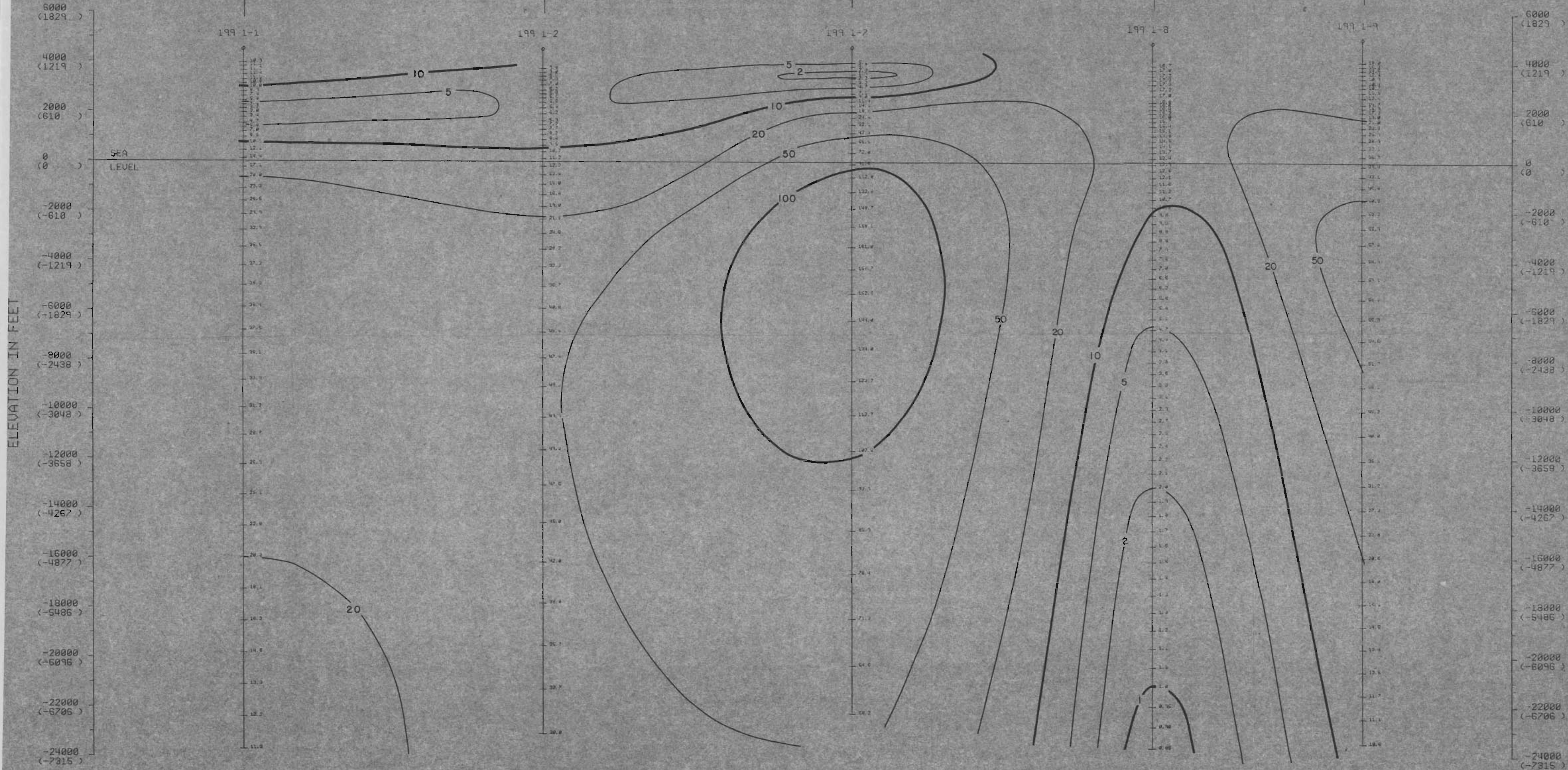

ELEVATION IN FEET

ELEVATION IN FEET

LEGEND
 CONTOUR VALUES:
 $1, 2, 5 \times 10^N$ OHM METERS

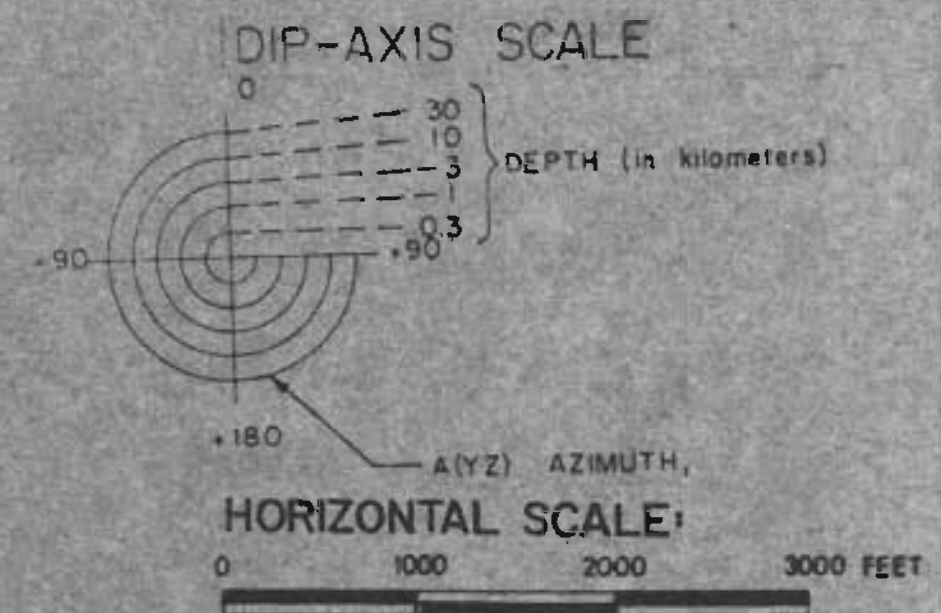

Geotronics Corp. Austin, Texas U.S.A.	
MAGNETOTELLURIC SURVEY	Survey Code
SUNEDCO-LEACH H.S., Nev.,	199
RESISTIVITY CROSS SECTION & DIP AXIS DIRECTIONS	
LINE B	RTE
INTERPRETER	4B
No. REVISIONS	
DATE	

C WEST

C EAST

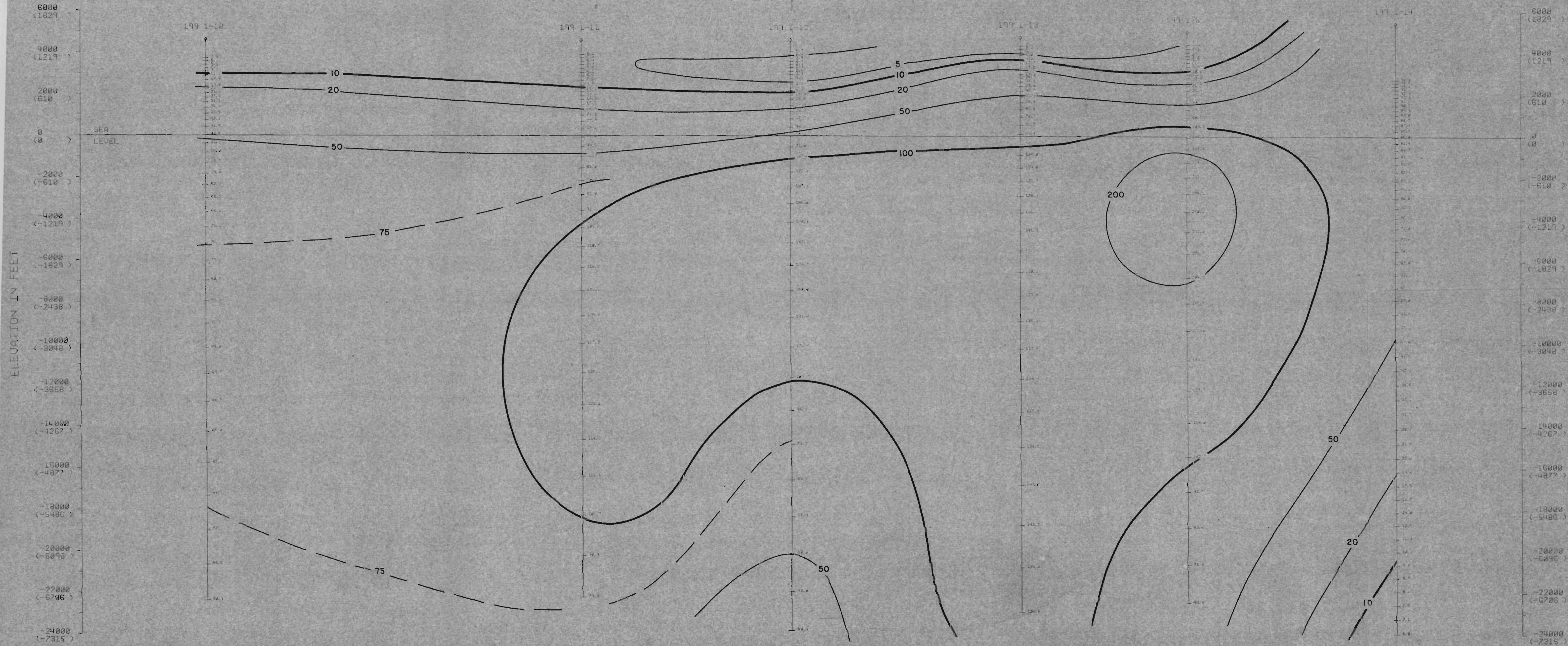

LEGEND

CONTOUR VALUES:
 $1,2,5 \times 10^N$ OHM METERS

DIP-AXIS SCALE

DEPTH (in kilometers)

HORIZONTAL SCALE:

Geonics Corp. Austin, Texas U.S.A.	
MAGNETOTELLURIC SURVEY	Survey Code
SUNEDCO-LEACH H.S., Nev.	199
RESISTIVITY CROSS SECTION & DIP AXIS DIRECTIONS	
LINE C	RTE
INTERPRETER	DATE
No. REVISIONS	DATE
4C	

D
WEST

D'
EAST

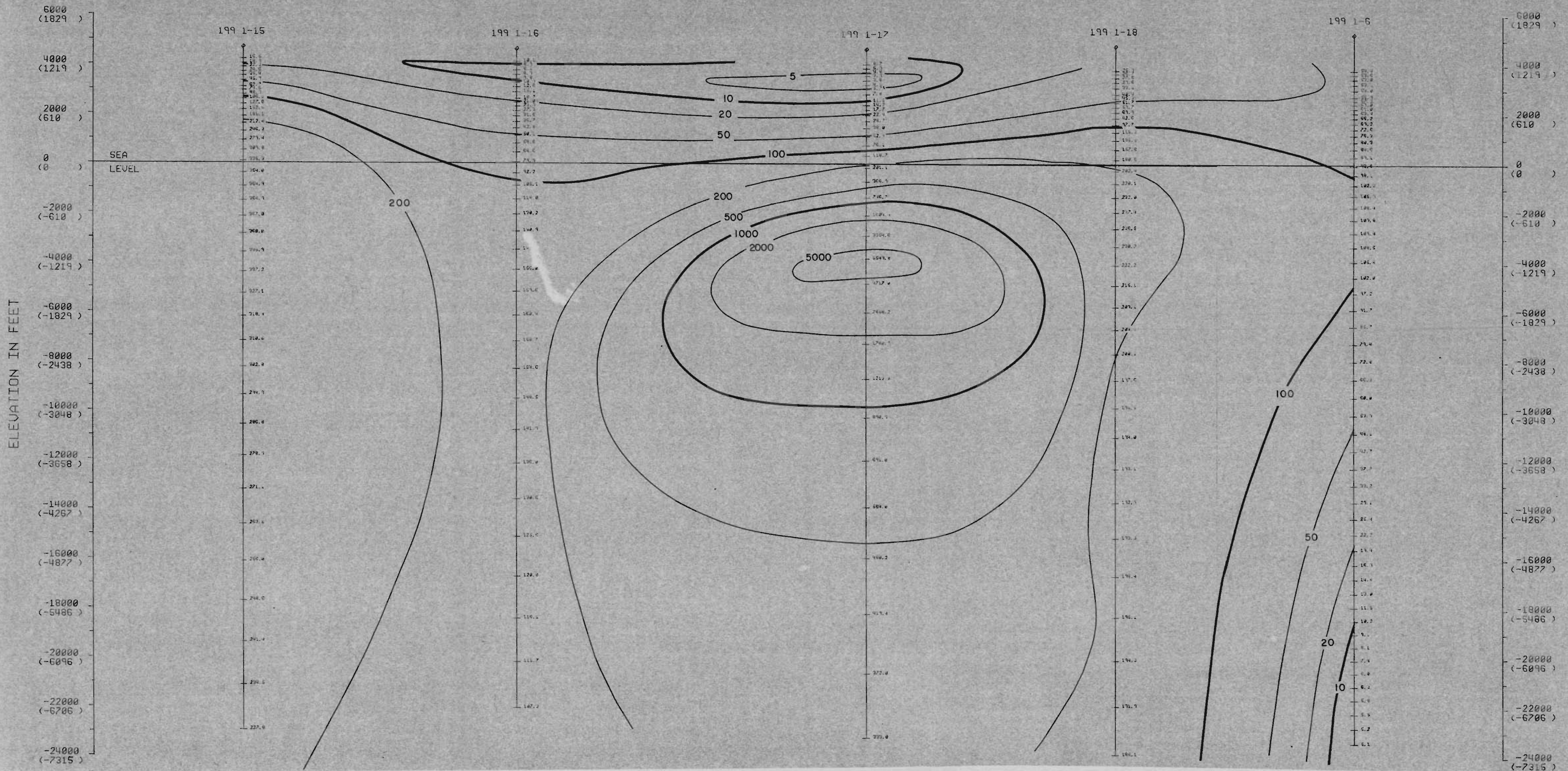
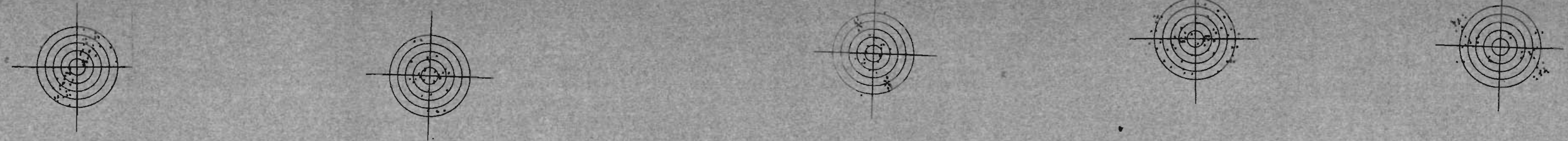

ELEVATION IN FEET

ELEVATION IN FEET

LEGEND
 CONTOUR VALUES:
 $1,2,5 \times 10^N$ OHM METERS

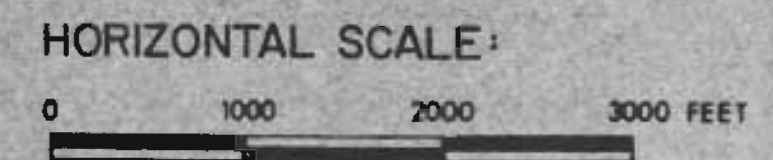
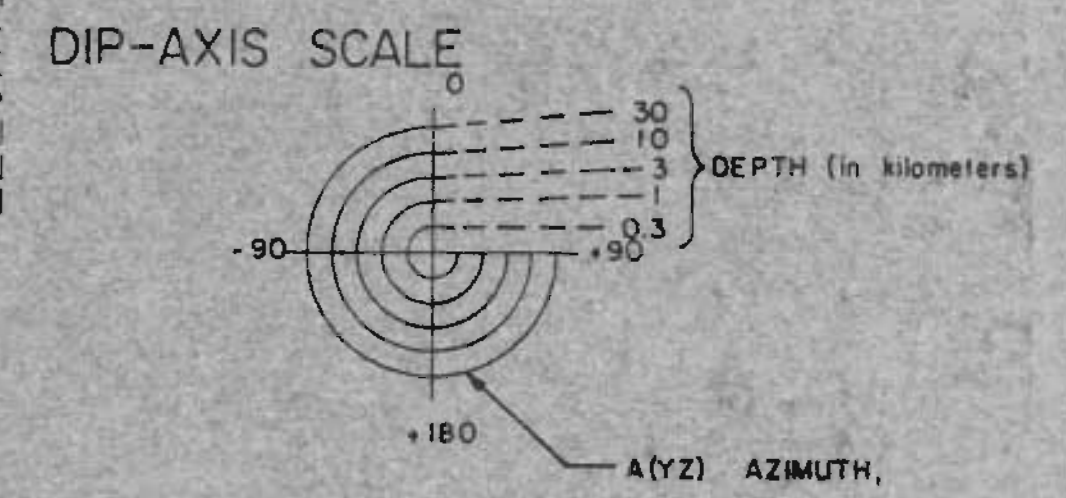

Geotronics Corp. Austin, Texas U.S.A.	
MAGNETOTELLURIC SURVEY	Survey Code
SUNEDCO-LEACH H.S., Nev.	199
RESISTIVITY CROSS SECTION & DIP AXIS DIRECTIONS	
LINE D	RTE
INTERPRETER	4D
No. REVISIONS	
DATE	

E
WEST

E
EAST

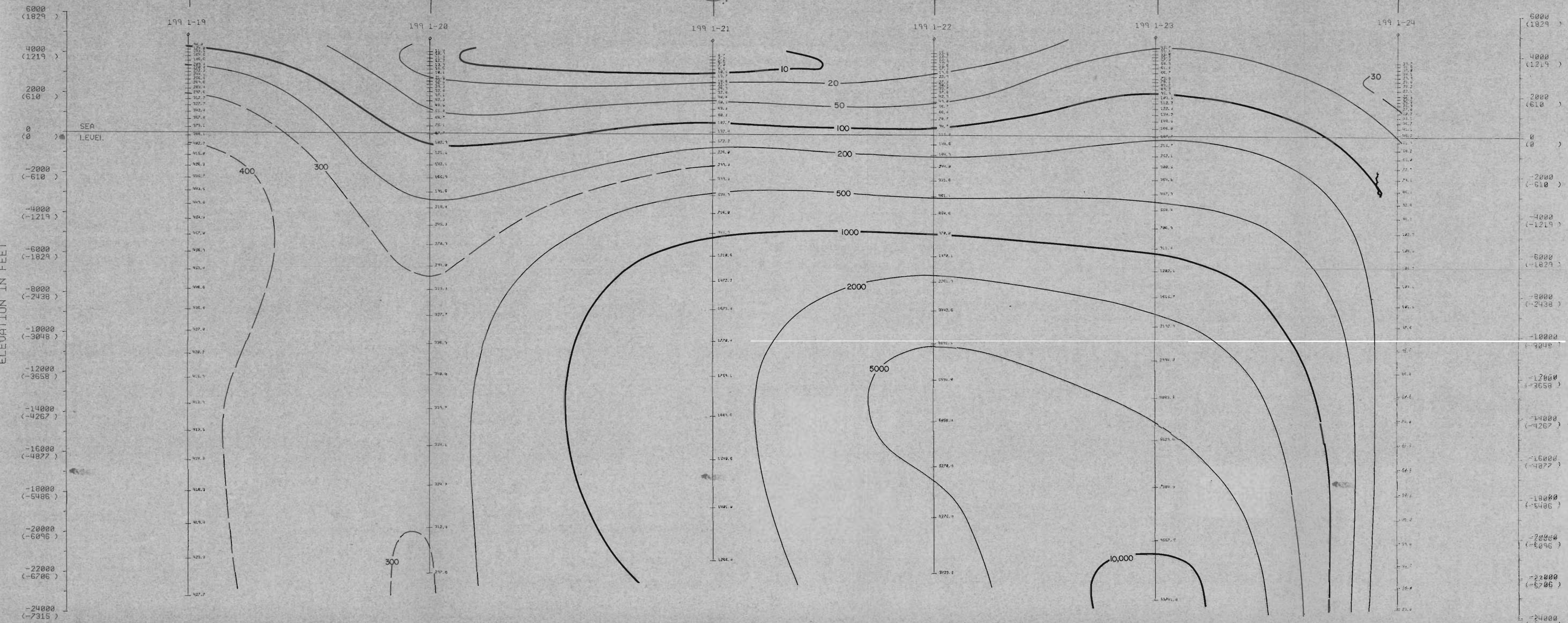

LEGEND
 CONTOUR VALUES:
 $1, 2, 5 \times 10^N$ OHM-METERS

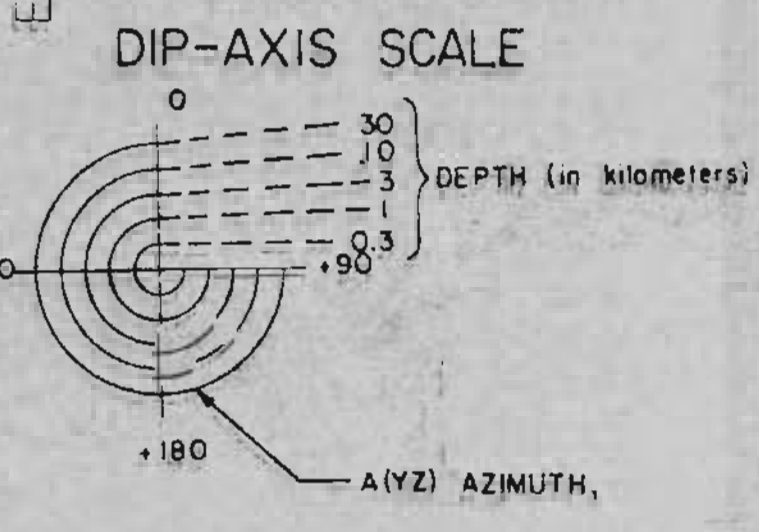
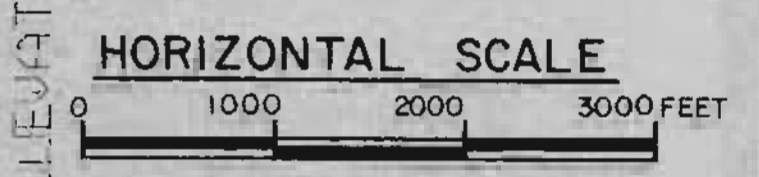

Geonics Corp. Austin, Texas U.S.A.	
MAGNETOTELLURIC SURVEY	Survey Code
SUNEDCO-LEACH H.S., NEV	199
TITLE	
RESISTIVITY CROSS SECTION DIP AXIS DIRECTIONS	
LINE E	RTE
INTERSECT	DATE
No. REVISIONS	DATE
	4E

F WEST

F EAST

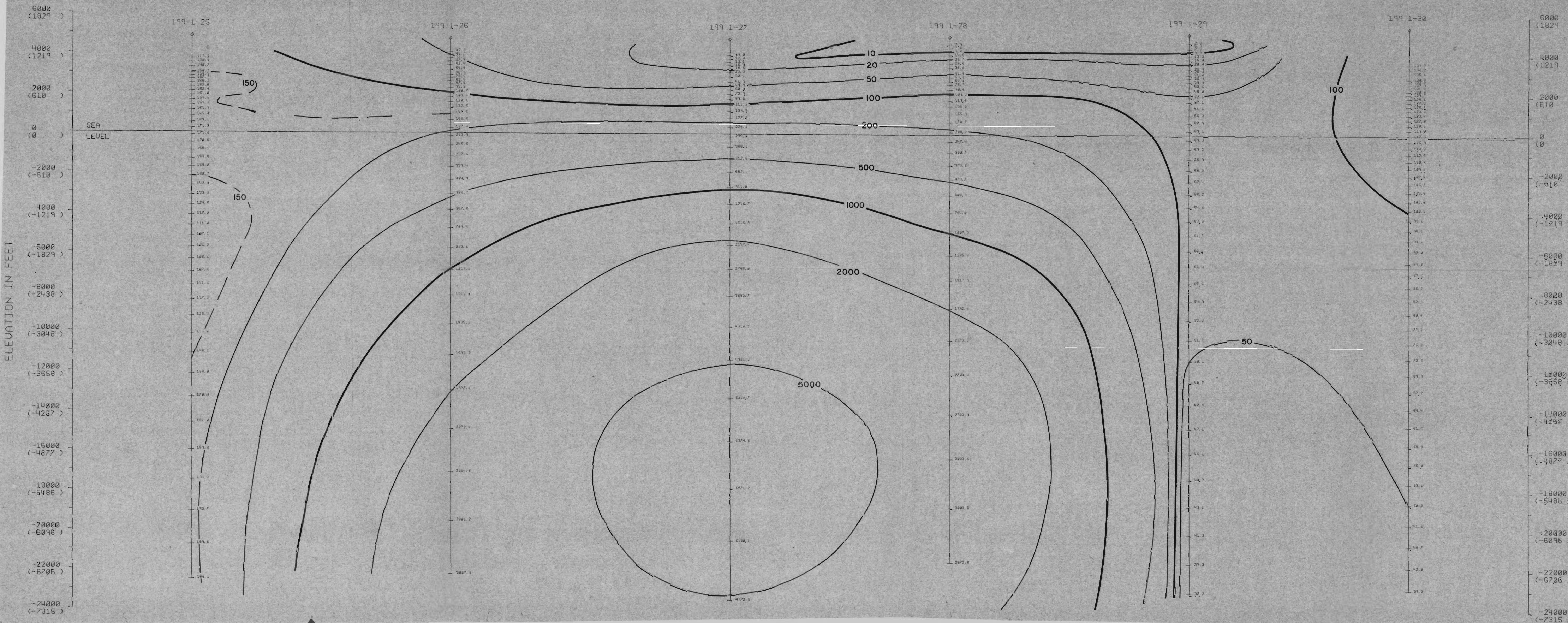
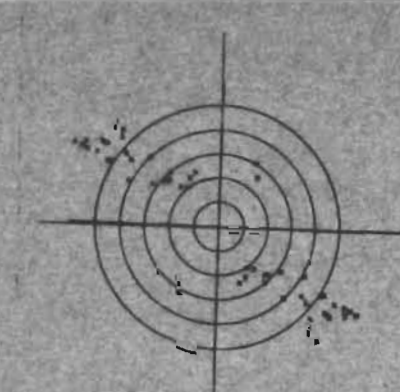
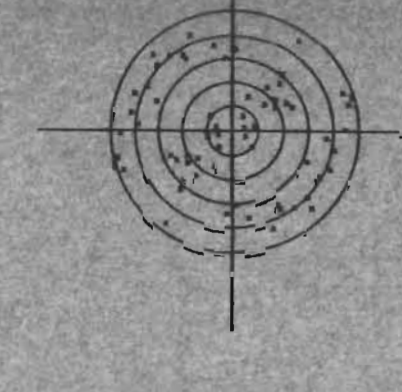
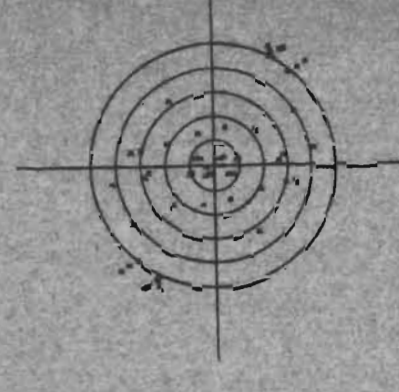
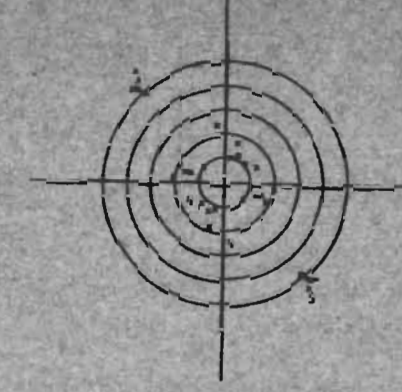
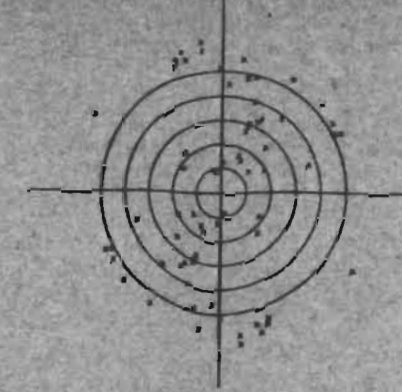
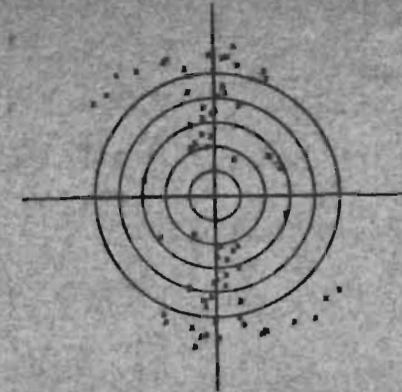

ELEVATION IN FEET

ELEVATION IN FEET

LEGEND
CONTOUR VALUES:
1, 2, 5 x 10ⁿ OHM METERS

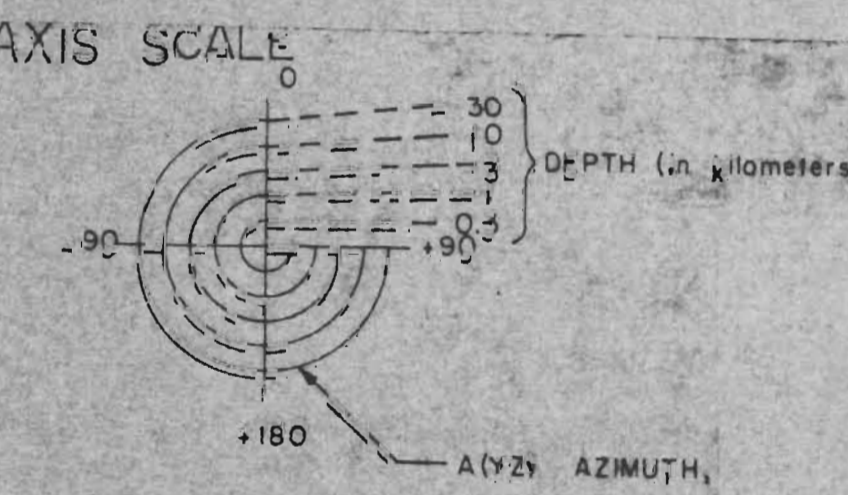

HORIZONTAL SCALE:
0 1000 2000 3000 FEET

Geotronics Corp.	
Austin, Texas U.S.A.	
MAGNETOTELLURIC SURVEY	Survey Code
SUNEDCO-LEACH H.S., Nev.	199
RESISTIVITY	
CROSS SECTION &	
DIP AXIS DIRECTIONS	
LINE F	RTE
INTERPRETER	
No	REVISIONS
	DATE
	4F

G WEST

G' EAST

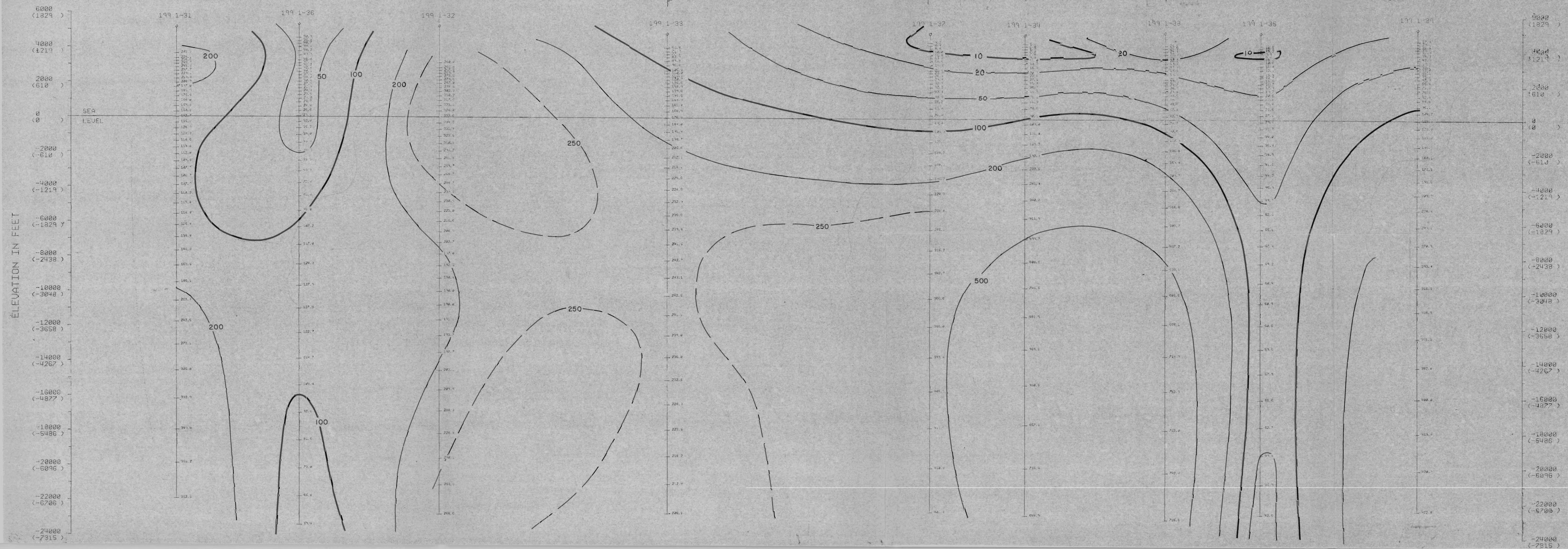

LEGEND

CONTOUR VALUES:
1,2,5 x 10ⁿ OHM METERS

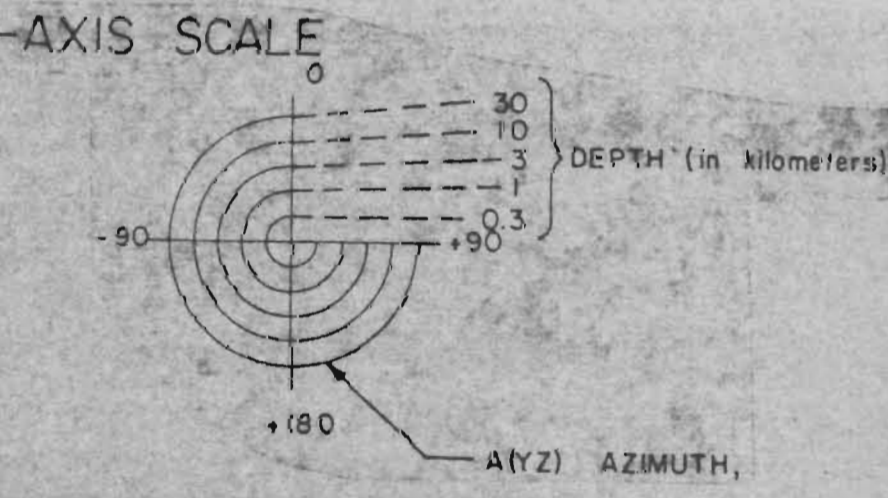

Geotronics Corp. Austin, Texas U.S.A.	
MAGNETOTELLURIC SURVEY	Survey Code
SUNEDCO-LEACH H.S., Nev.,	199
RESISTIVITY CROSS SECTION & DIP AXIS DIRECTIONS	
LINE G	RTE
INTERPRETER	DATE
NO. REVISIONS	4G

A
NORTHWEST

A'
SOUTHEAST

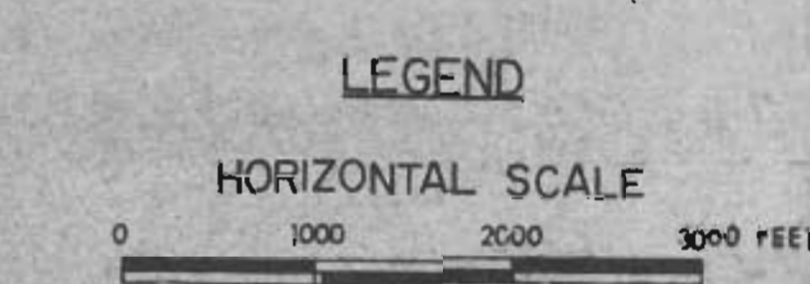
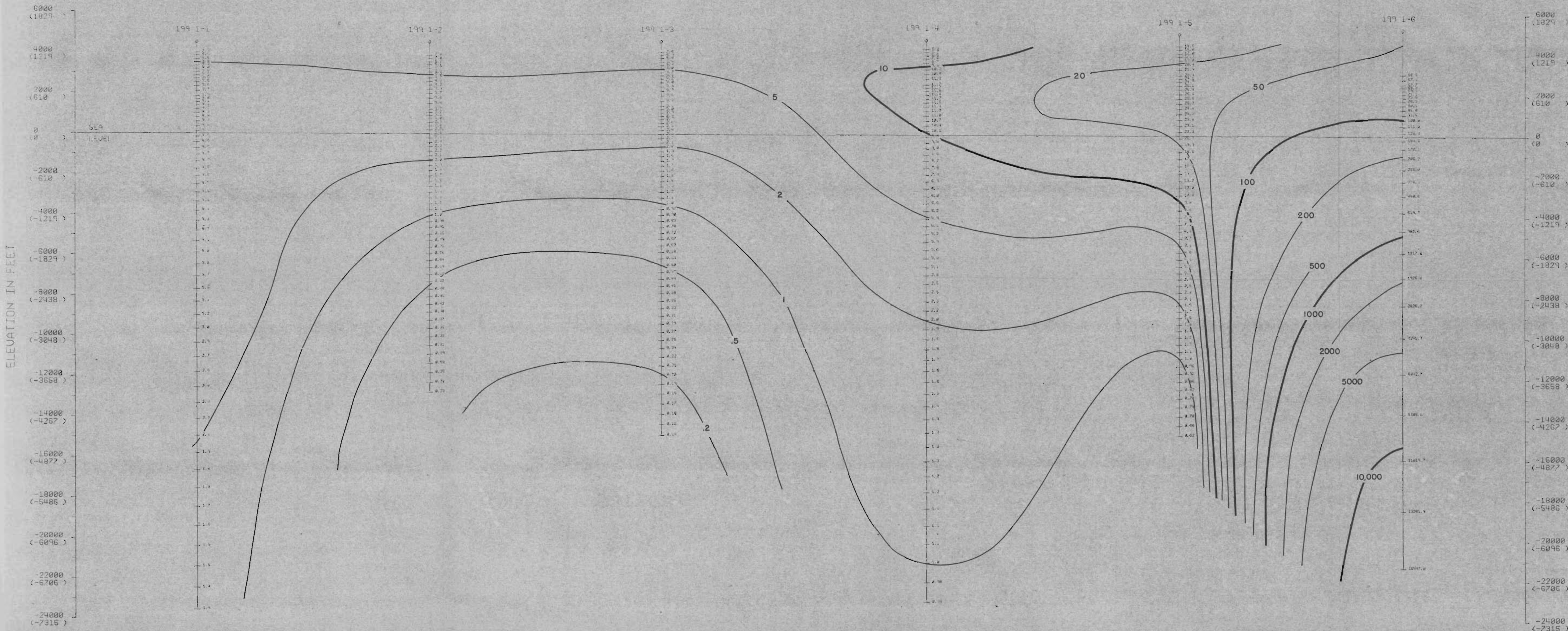

CONTOUR VALUES: OHM METERS
1, 2, 5, x 10^N

Geotronics Corp. Austin, Texas U.S.A.		Survey Code
MAGNETOTELLURIC SURVEY		199
SUNEDCO-LEACH H.S., NEW		
TITLE: RESISTIVITY CROSS SECTION		
LINE A		RTM
INTERPRETER	REVISIONS	DATE
		5A

B
WEST

B'
EAST

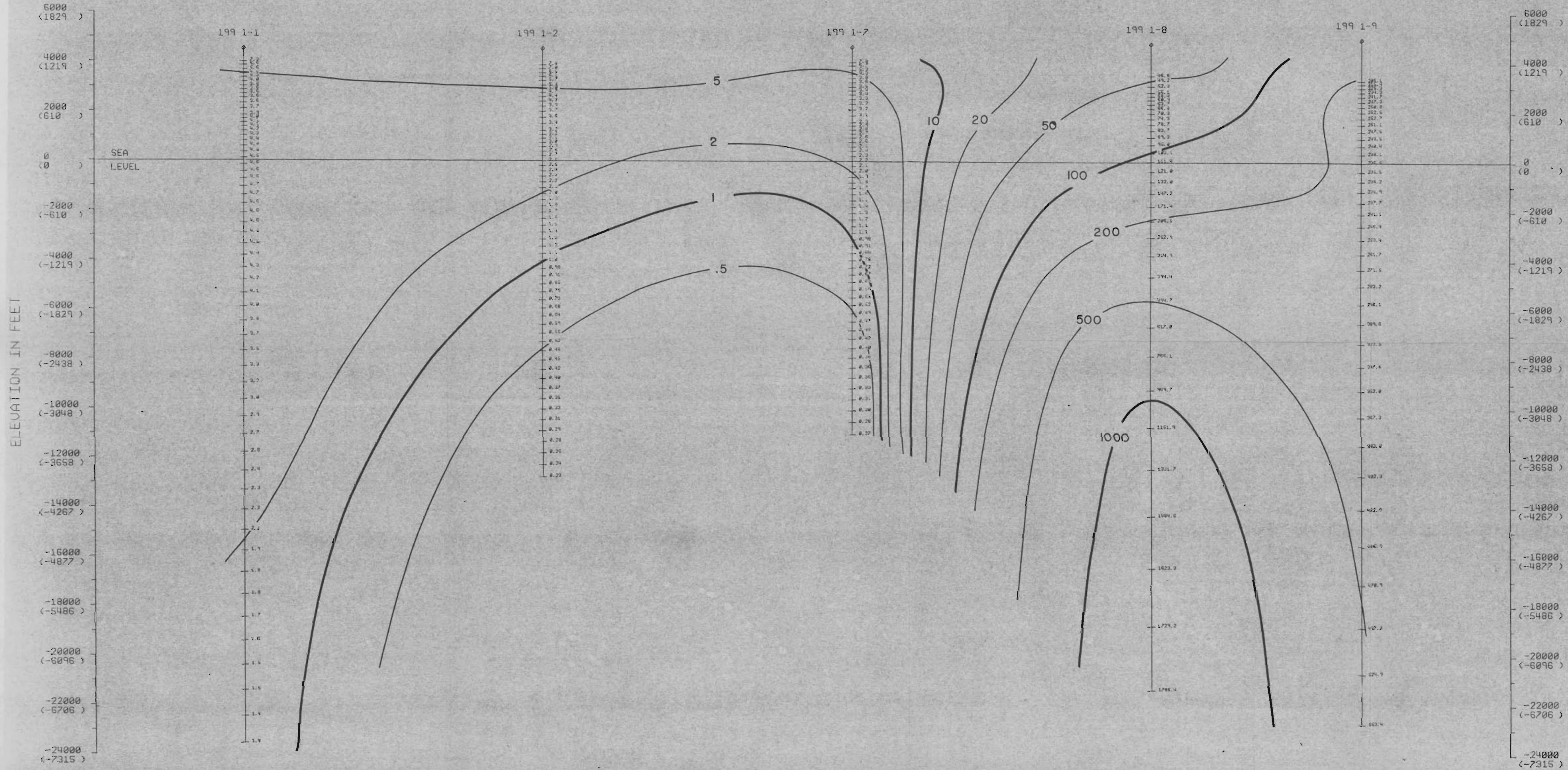

ELEVATION IN FEET

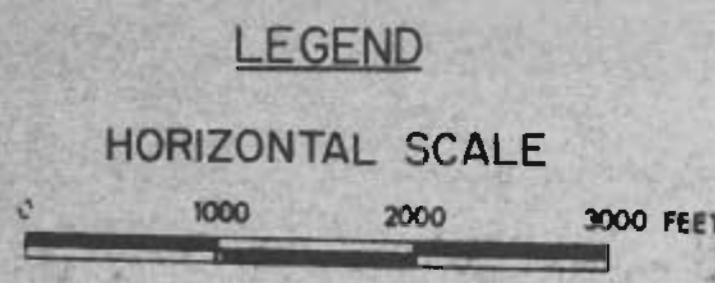

CONTOUR VALUES: OHM METERS
1,2,5, x 10^N

Geotronics Corp. Austin, Texas U.S.A.	
MAGNETOTELLURIC SURVEY SUNEDCO-LEACH H.S., Nev.	Survey Code 199
RESISTIVITY CROSS SECTION	
LINE B	RTM
INTERPRETER	DATE
No. REVISIONS	DATE
5B	

C
WEST

C'
EAST

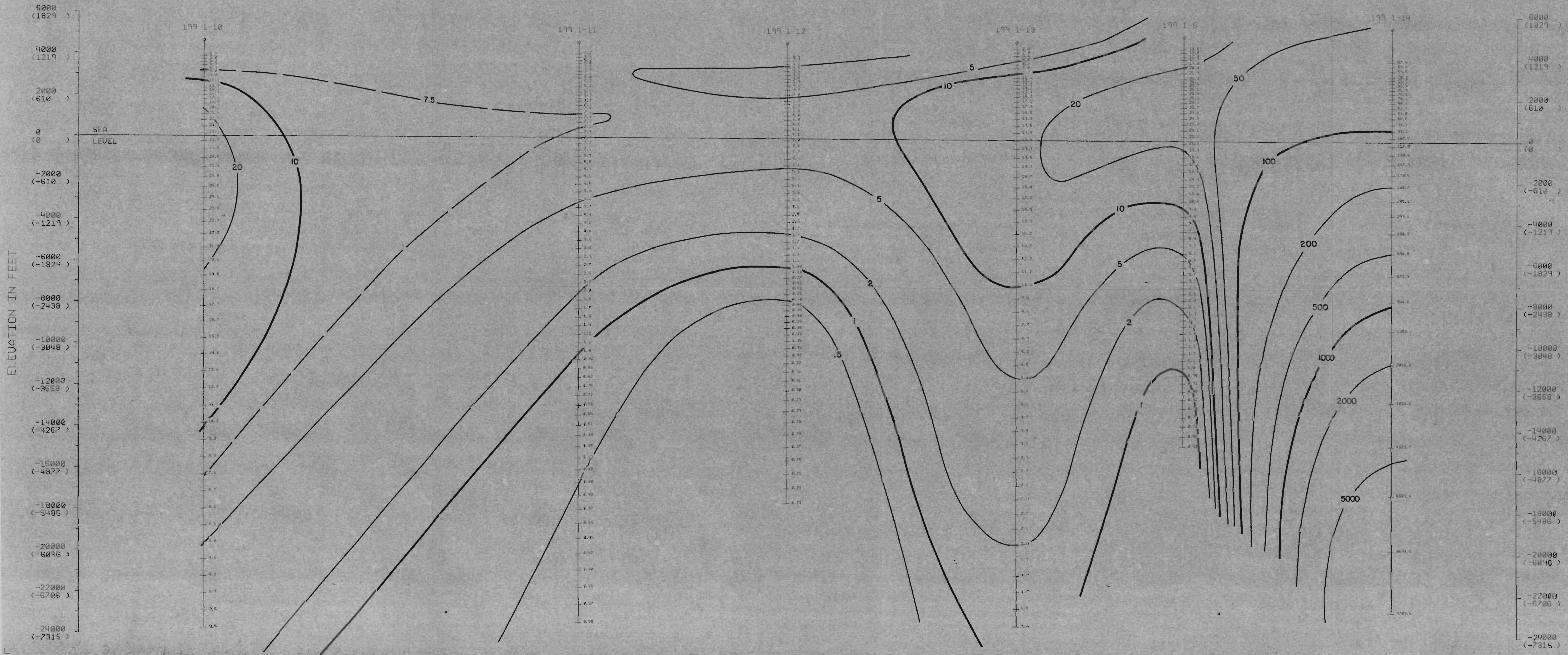

LEGEND

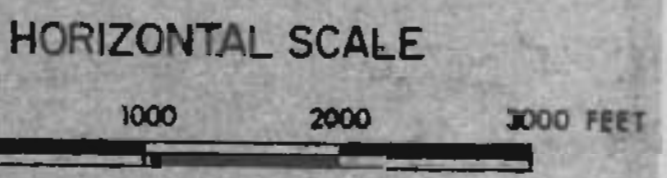

CONTOUR VALUES: OHM METERS
1,2,5, x 10^N

Geotronics Corp. Austin, Texas U.S.A.		Survey Code
MAGNETOTELLURIC SURVEY		199
SUNEDCO-LEACH H.S., Nev.		
RESISTIVITY CROSS SECTION		
LINE C		RTM
INTERPRETER	REVISIONS	DATE
		5C

D
WEST

D'
EAST

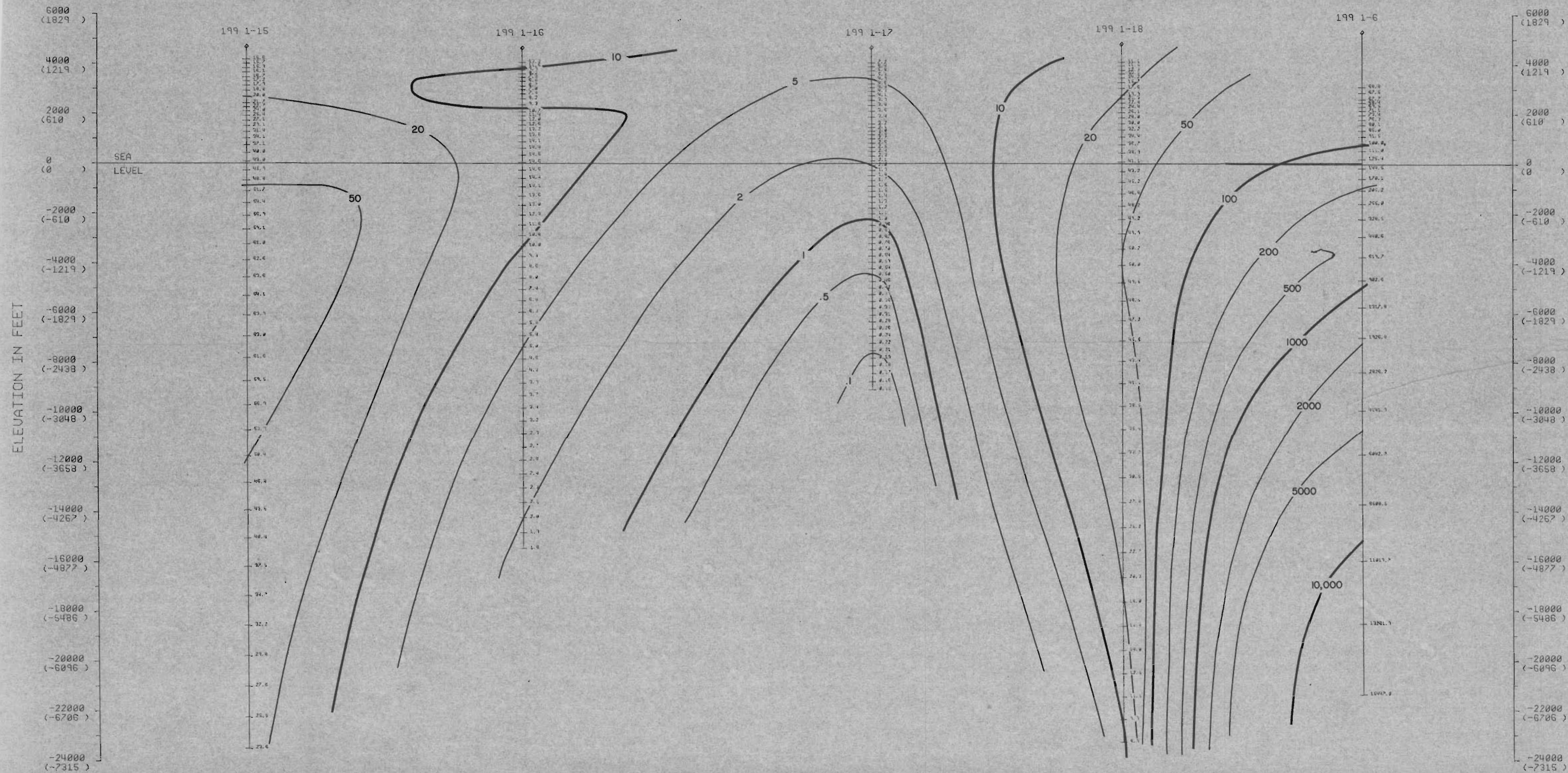

ELEVATION IN FEET

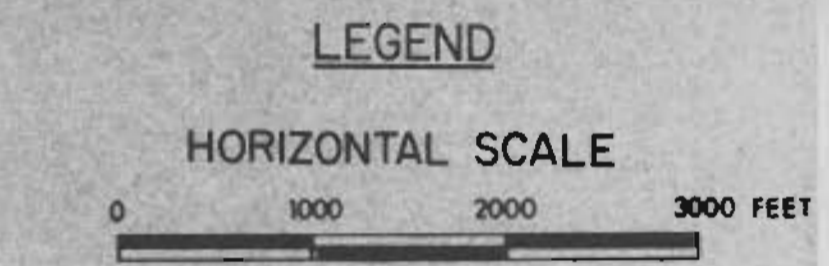

CONTOUR VALUES: OHM METERS
1, 2, 5, x 10^N

Geotronics Corp. Austin, Texas U.S.A.	
MAGNETOTELLURIC SURVEY	Survey Code
SUNEDCO-LEACH H.S., Nev.	199
RESISTIVITY CROSS SECTION	
LINE D	RTM
INTERPRETER	
No.	REVISIONS
	DATE
5D	

F
WEST

F'
EAST

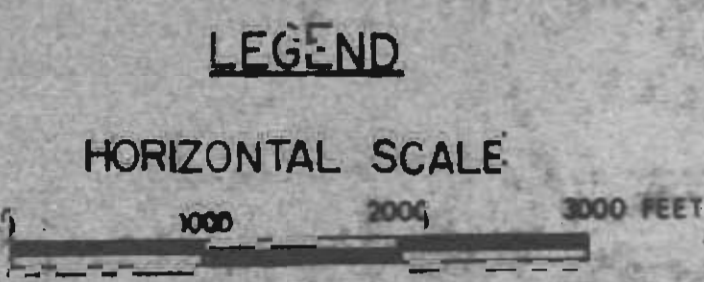
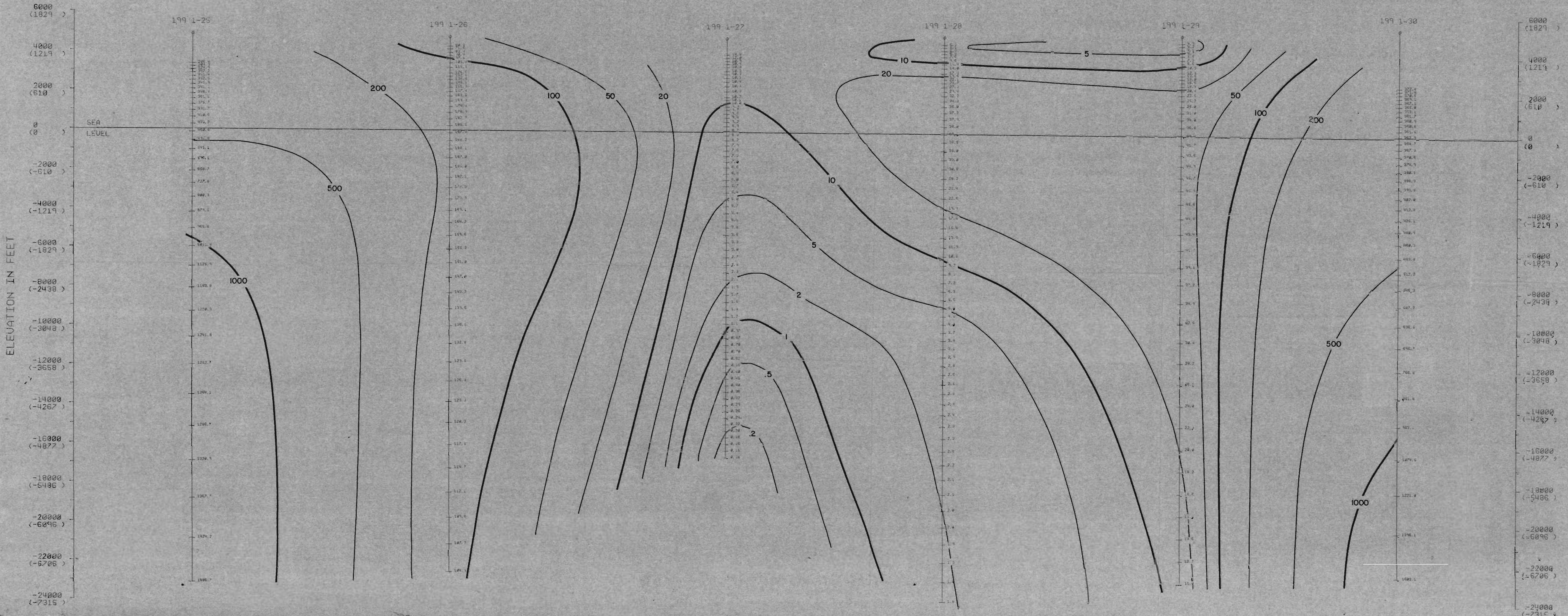

CONTOUR VALUES: OHM METERS
1,2,5, x 10^N

Geotronics Corp. Austin, Texas U.S.A.	
MAGNETOTEL LONIC SURVEY	Survey Code
SUNEDCO-LEASH H.S., Nev.	109
RESISTIVITY CROSS SECTION	
LINE F	RTM
DATE	5F

G
WEST

G'
EAST

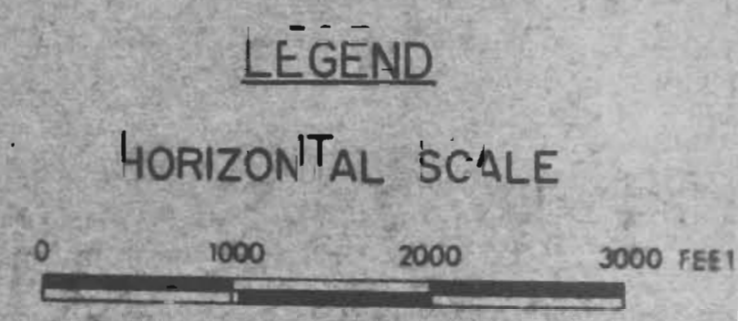
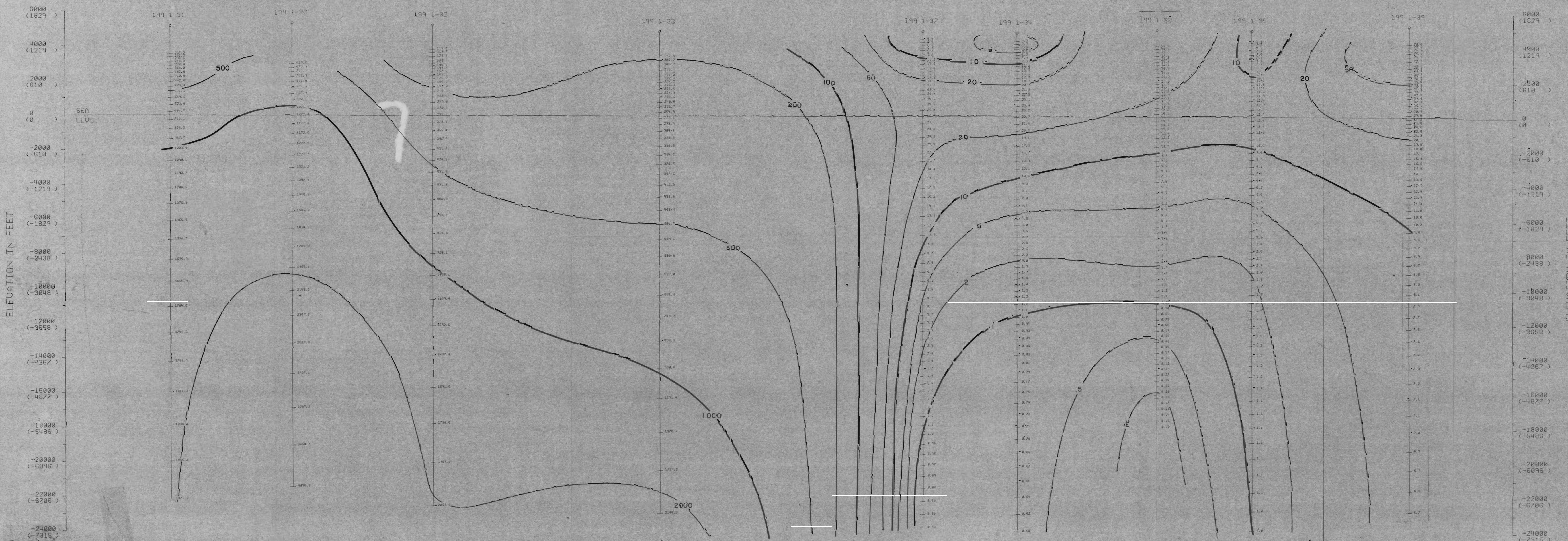

CONTOUR VALUES: OHM METERS
1:2.5, x 10^N

Geotronics Corp. Austin, Texas U.S.A.	
MAGNETOTELLURIC SURVEY	Survey Code
SUNOCO-LEACH H.S., No. 1	199
RESISTIVITY CROSS SECTION	
LINE G	RTM
INTERPRETER	DATE
REVISIONS	5G

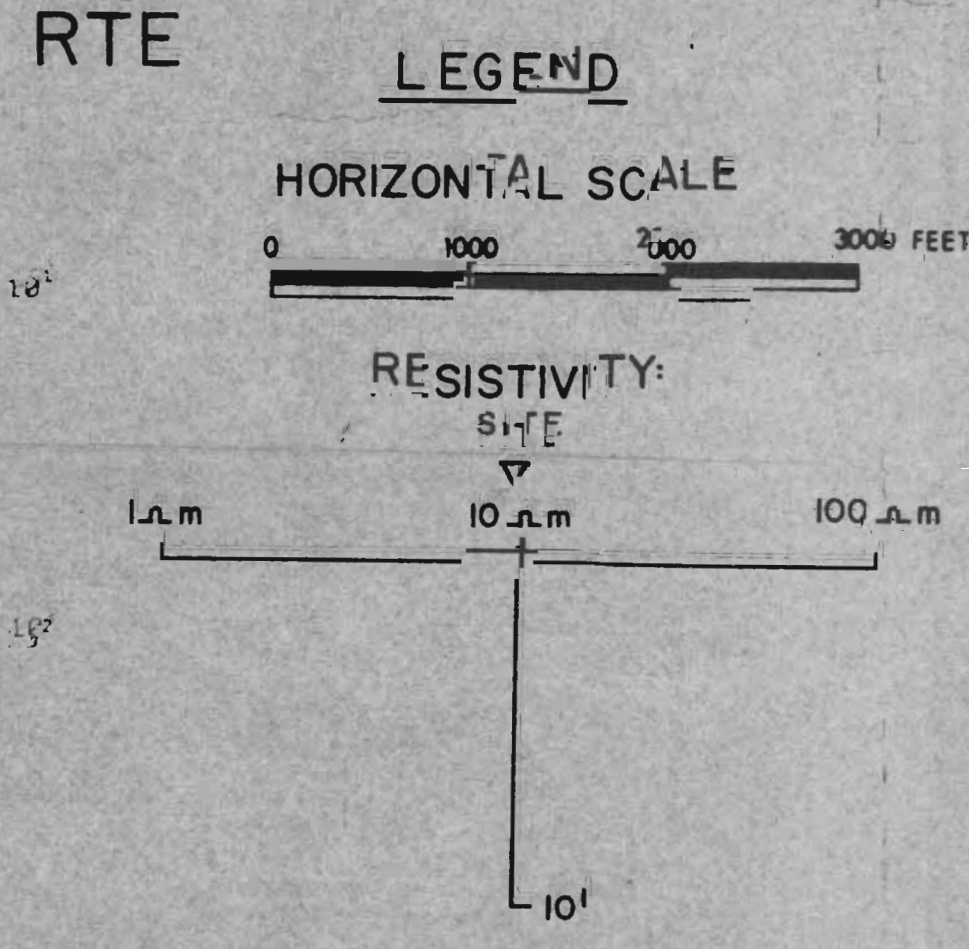
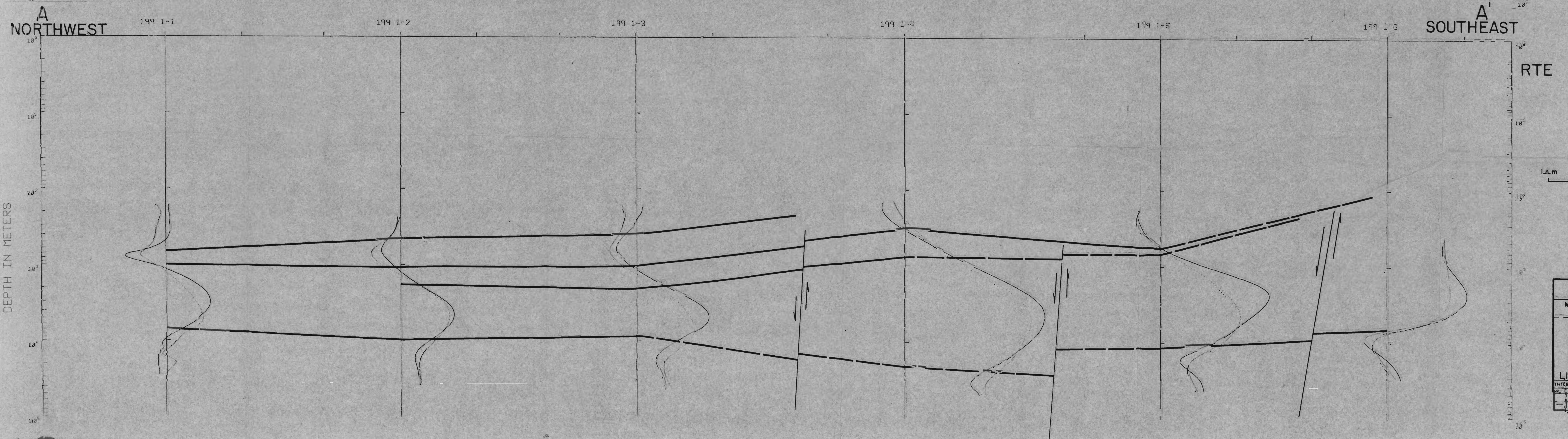
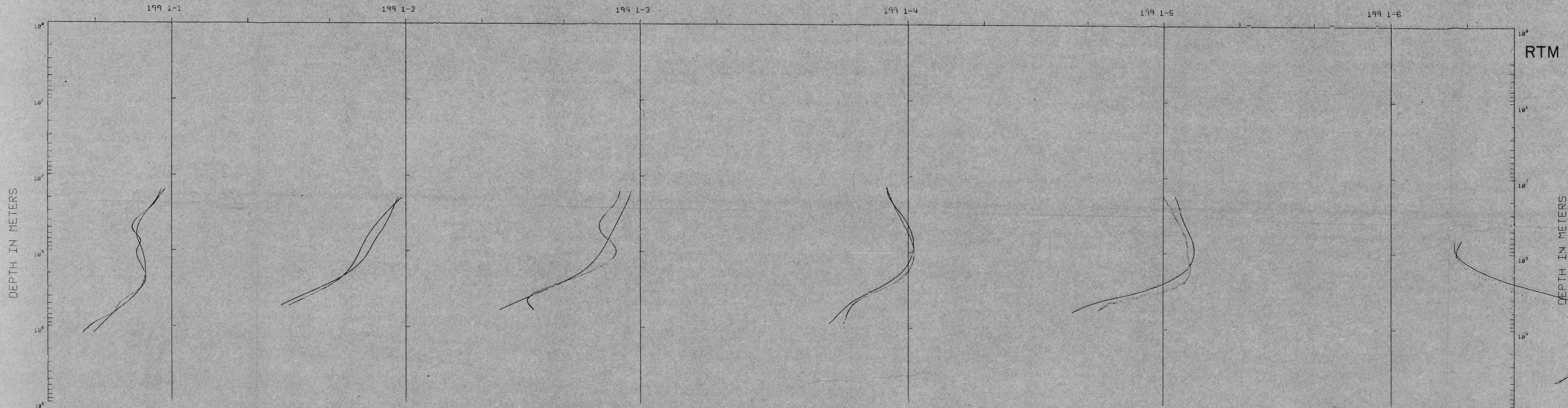

Geotronics Corp.		Austin, Texas U.S.A.	
MAGNETOTELLURIC SURVEY	SUNEDOP	LEACH H. S.	199
CORRELATION CROSS SECTION			
L98-1.08			
LINE A	INTERPRETER	RTM/RTE	5A

B
WEST

B'
EAST

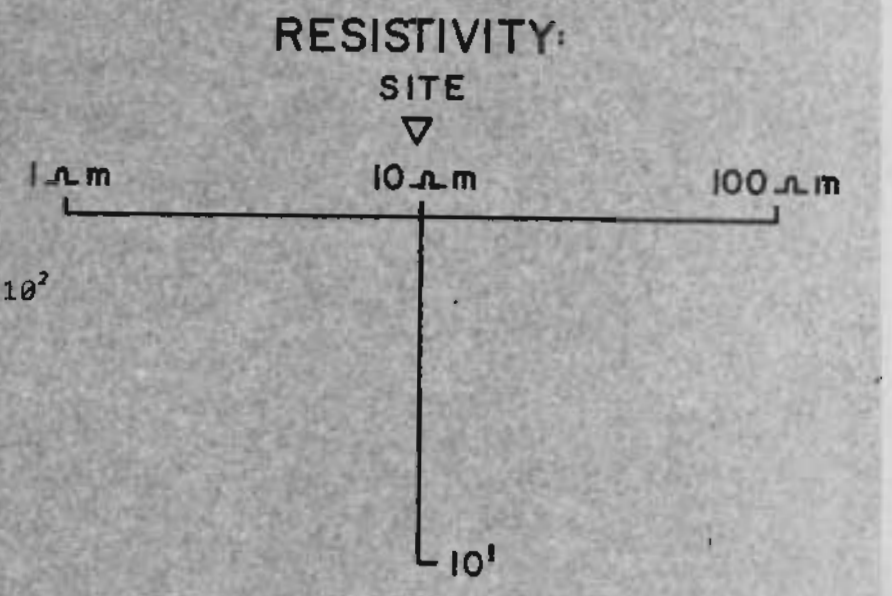
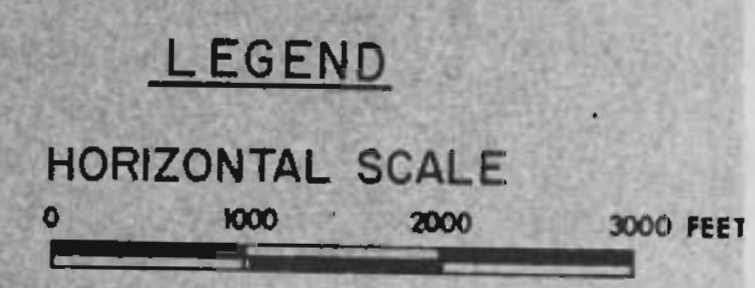
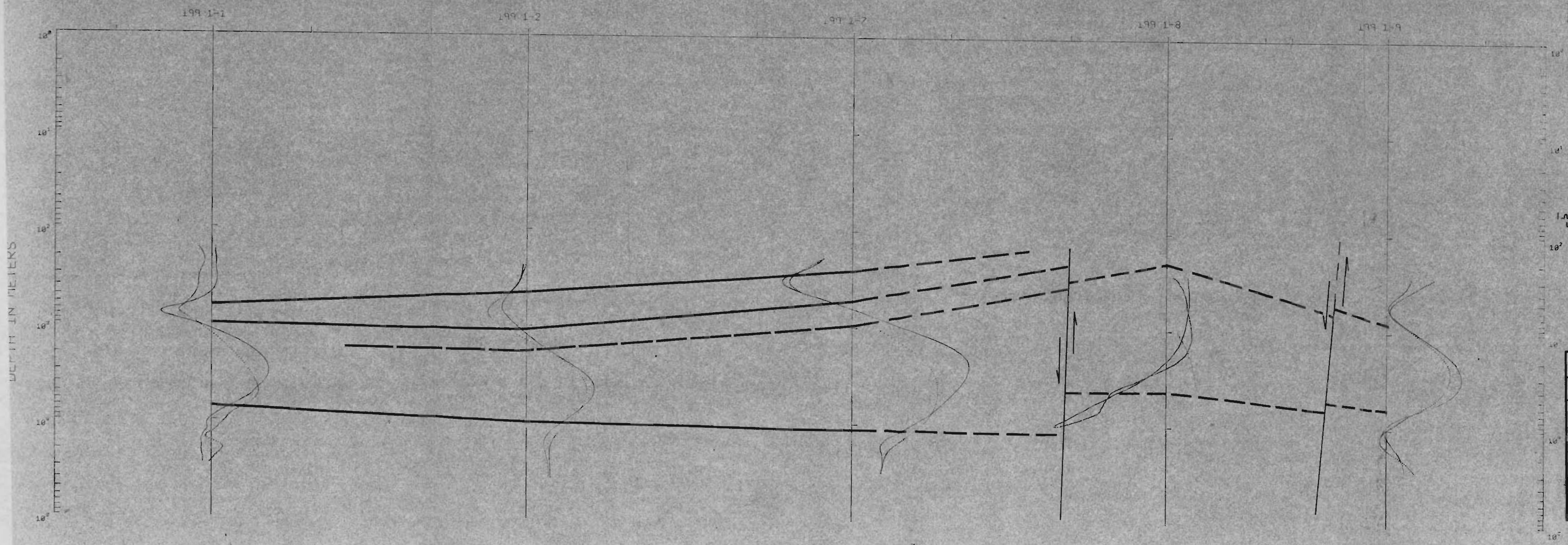

Geotronics Corp. Austin, Texas U.S.A.		
MAGNETOTELLURIC SURVEY	Survey Code	199
SUNEDCO-LEACH H.S., Nev.		
CORRELATION CROSS SECTION LOG-LOG		
LINE B		RTM/RTE
INTERPRETER	REVISIONS	DATE
		6B

C
WEST

C'
EAST

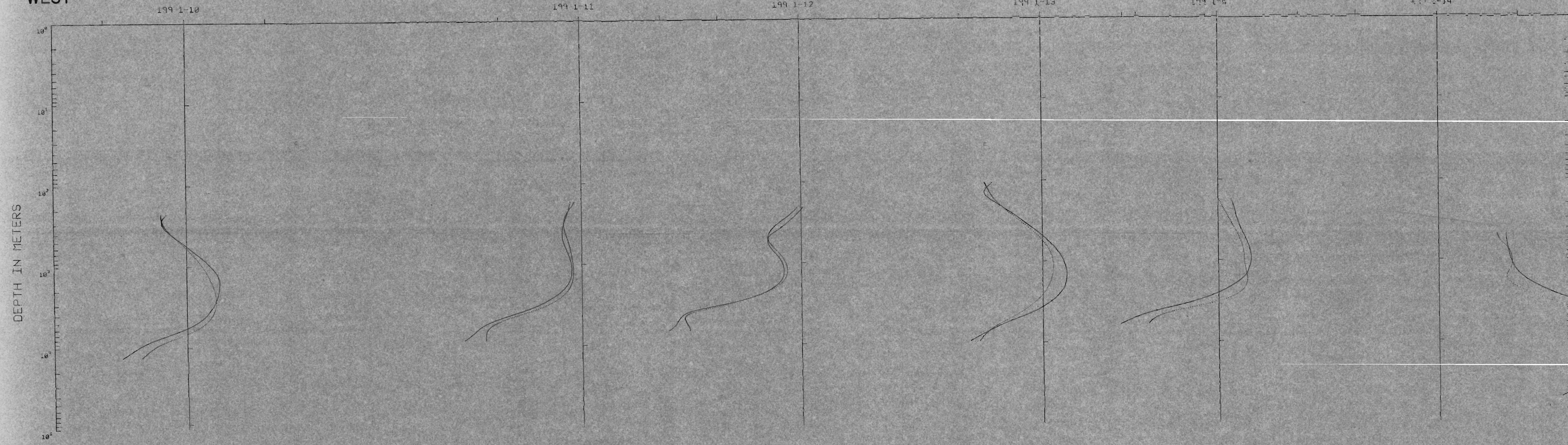

RTM

DEPTH IN METERS

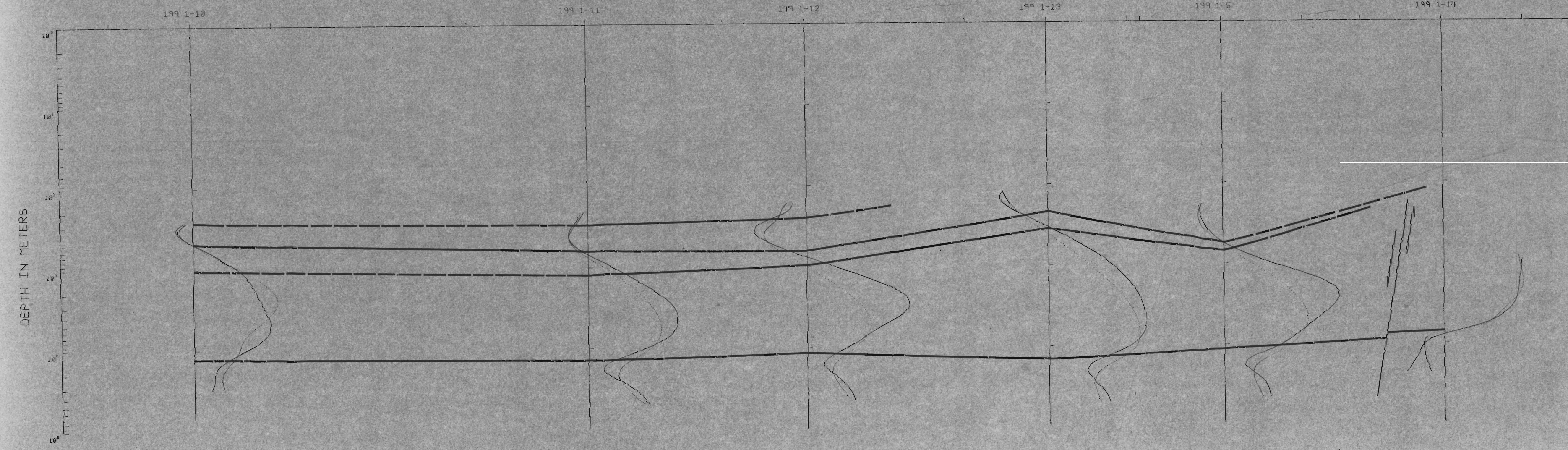

RTE

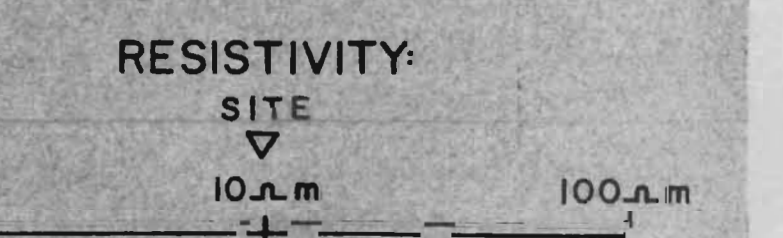
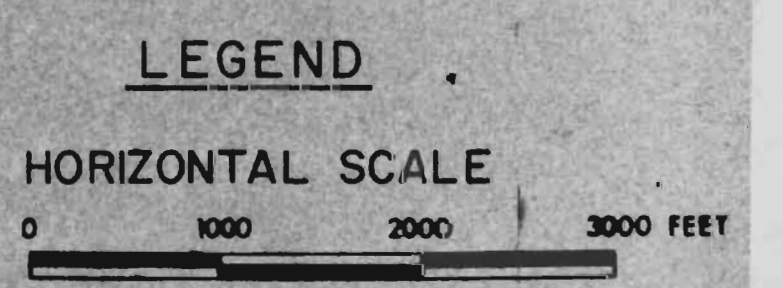

Geotronics Corp.		Austin, Texas U.S.A.	
MAGNETOTELLURIC SURVEY		Survey Code	199
SLINEDCO-LEACH H.S., Nev.			
CORRELATION CROSS SECTION LOG-LOG			
LINE C		RTM/RTE	
INTERPRETER	REVISIONS	DATE	6C
No.			

D
WEST

D'
EAST

199 1-15

199 1-16

199 1-17

199 1-18

199 1-6

DEPTH IN METERS

DEPTH IN METERS

RTM

199 1-15

199 1-16

199 1-17

199 1-18

199 1-6

DEPTH IN METERS

RTE

LEGEND

HORIZONTAL SCALE



RESISTIVITY:

SITE

▽

100 m 1000 m 10000 m

10¹

Geotronics Corp. Austin, Texas U.S.A.		Survey Code
MAGNETOTELLURIC SURVEY		199
SUNEDCO-LEACH H.S., Nev.		
CORRELATION CROSS SECTION LOG-LOG		
LINE D		RTM/RTE
INTERPRETER		
No.	REVISIONS	DATE
		6D

E
WEST

E
EAST

199 1-19

199 1-20

199 1-21

199 1-22

199 1-23

199 1-24

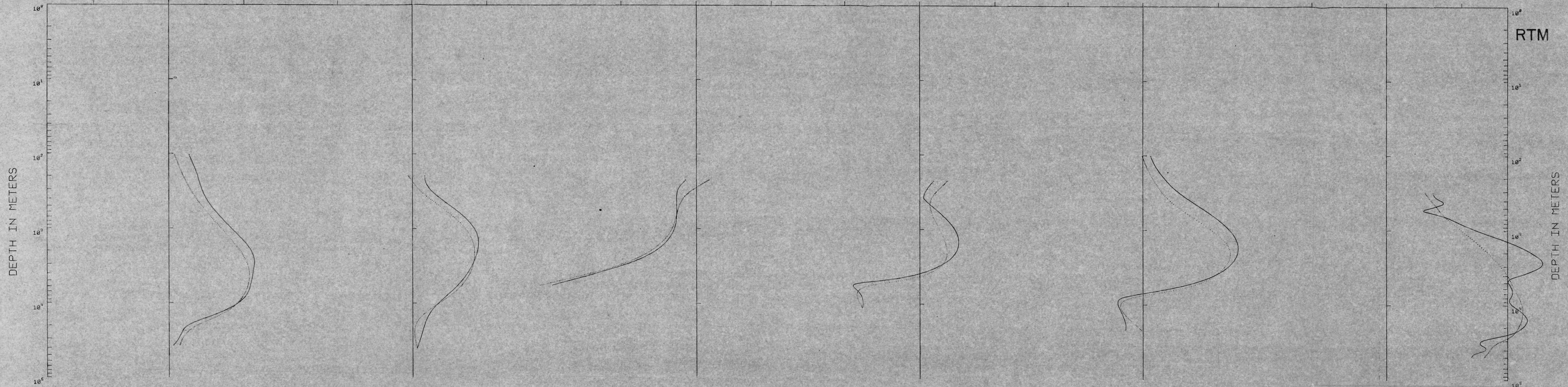

199 1-19

199 1-20

199 1-21

199 1-22

199 1-23

199 1-24

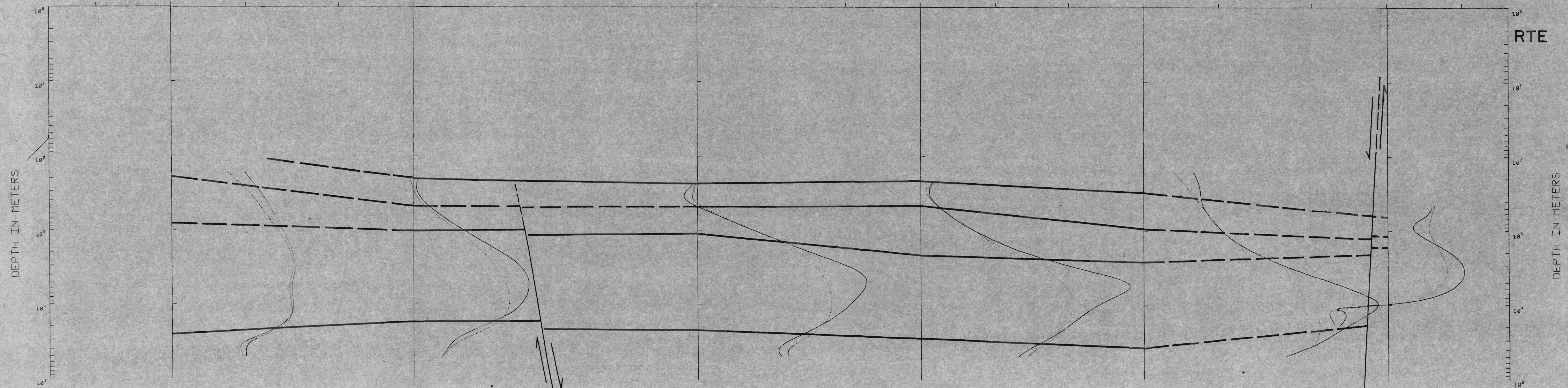

LEGEND

HORIZONTAL SCALE

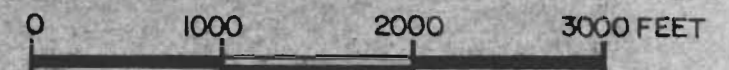

RESISTIVITY:

SITE

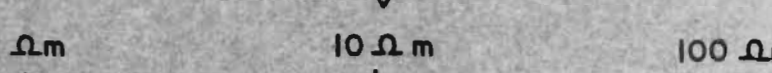

DEPTH IN METERS

RTE

10⁰

10¹

10²

10³

10⁴

10⁵

10⁶

Geotronics Corp. Austin, Texas U.S.A.		Survey Code 199
MAGNETOTELLURIC SURVEY SUNEDCO-LEACH H.S. Nev.		
TITLE: CORRELATION CROSS SECTION LOG-LOG		
LINE E		RTM/RTE
INTERPRETER		
No.	REVISIONS	DATE
		6E

199 1-25

199 1-26

199 1-27

199 1-28

199 1-29

199 1-30

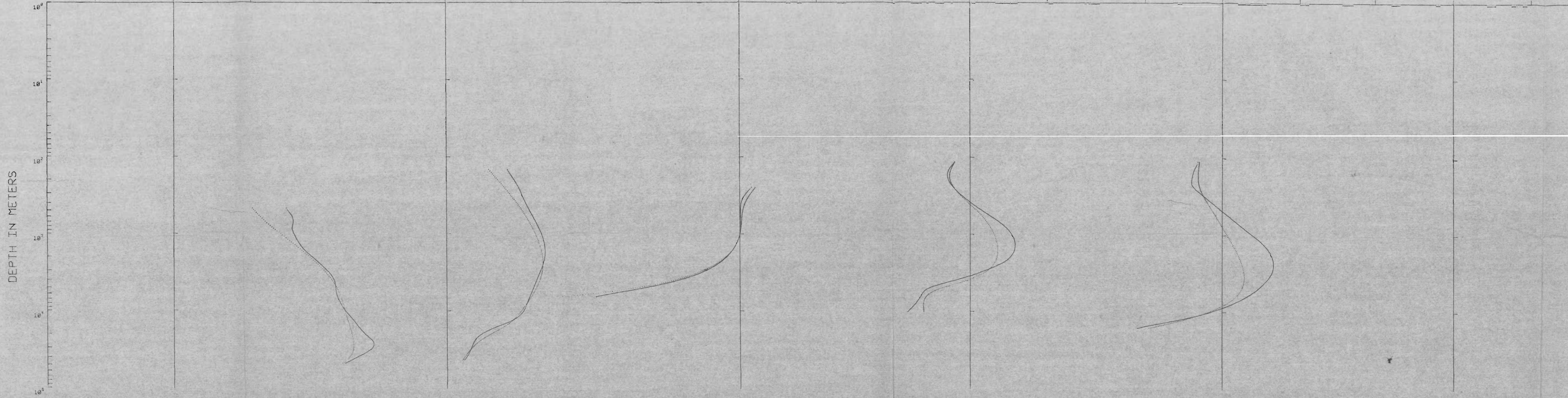

RTM

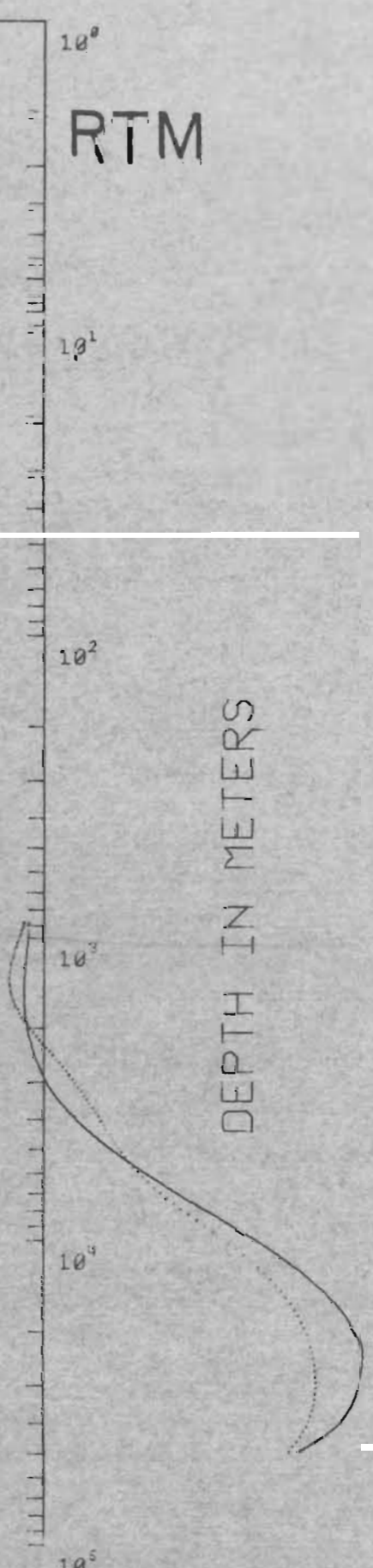

F WEST

199 1-25

199 1-26

199 1-27

199 1-28

199 1-29

199 1-30

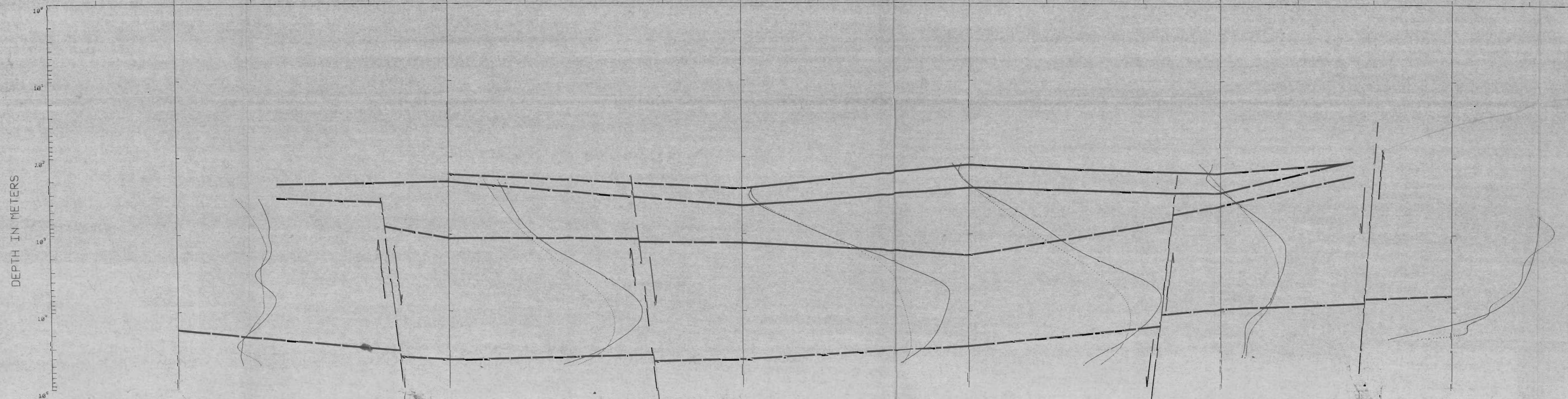

F EAST

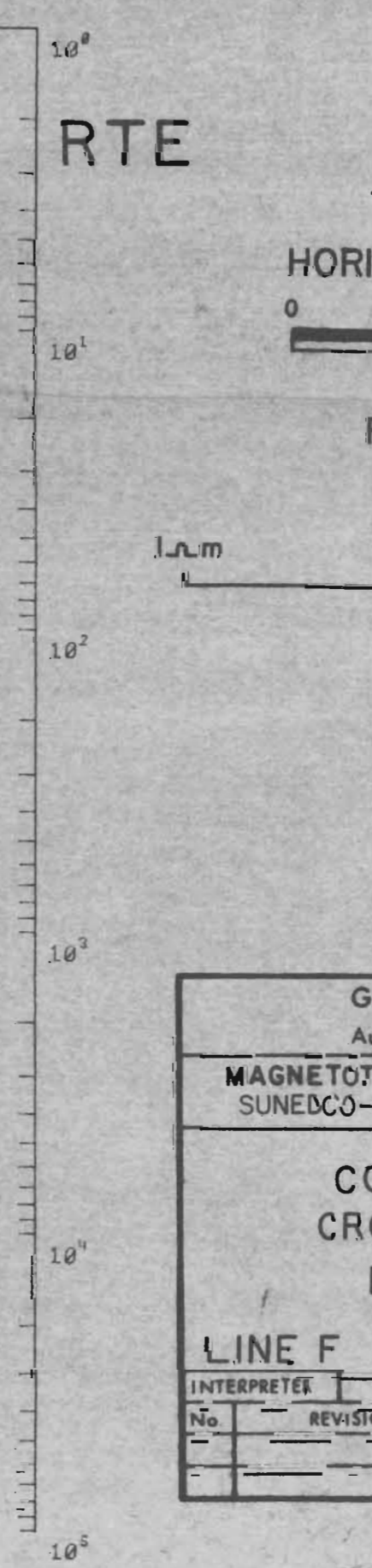

RTE

LEGEND

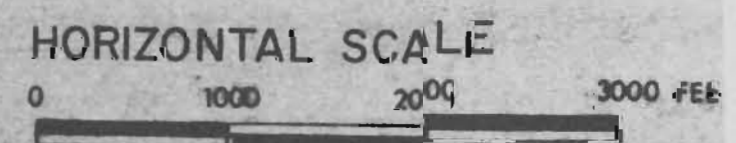

RESISTIVITY

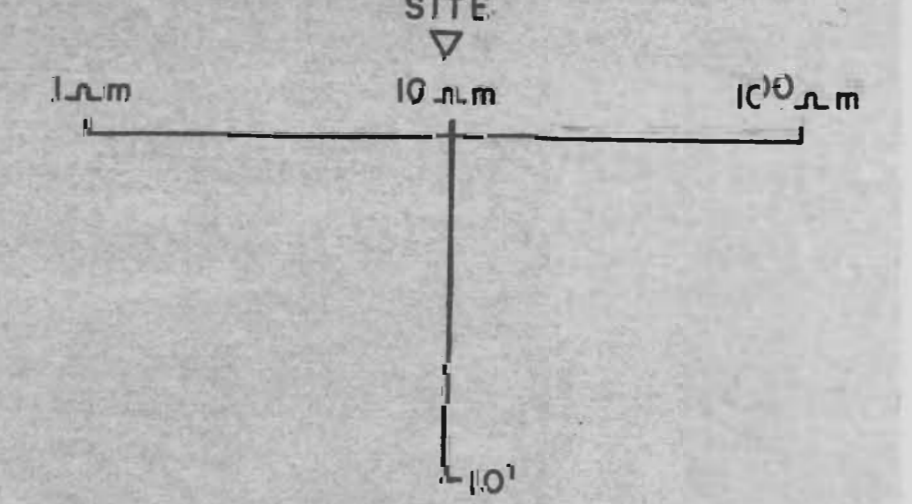

Geotronics Corp. Austin, Texas U.S.A.	
MAGNETOTELLURIC SURVEY	Site Code
SUNEDCO-LEACH H.S. (N.B.)	1993
CORRELATION CROSS SECTION LOG-LOG	
LINE F	RTM/RTE
INTERPRETER	DATE
No. REVISED	DATE
	GF

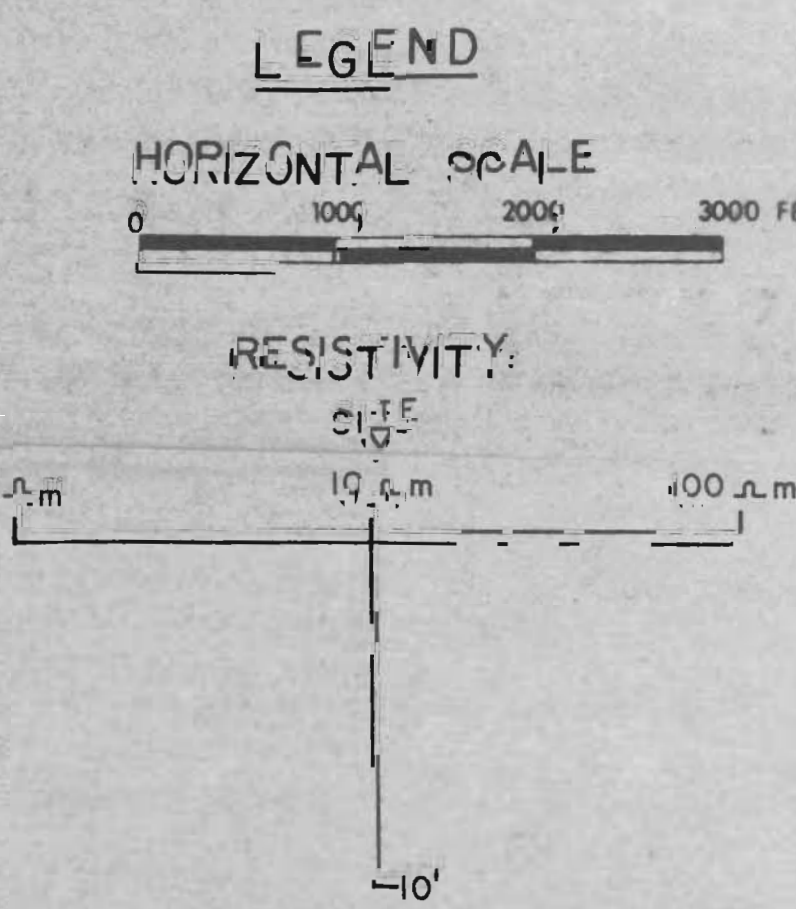
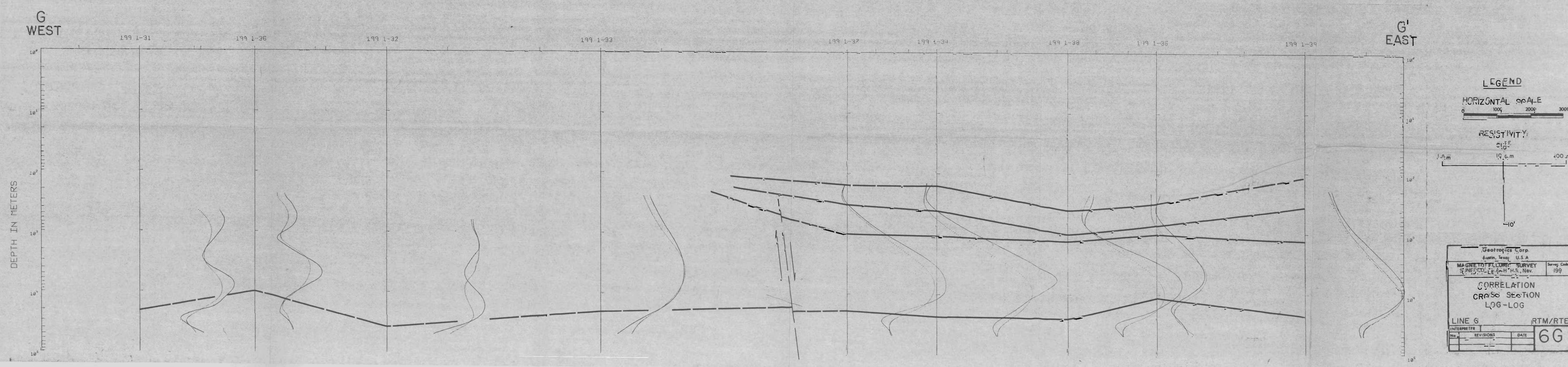
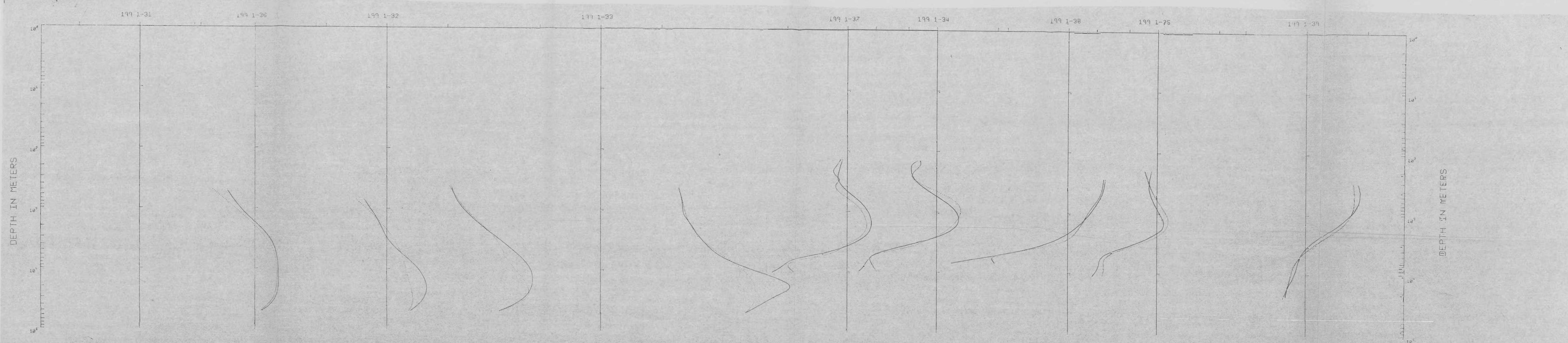

Geotronics Corp. Austin, Texas, U.S.A.		Survey Code
MAGNETOTELLURIC SURVEY		199
SANDCOCK, L.E. & H.H.S., Nev.		
CORRELATION CROSS SECTION LOG-LOG		
LINE G		RTM/RT
INTERPRETER	REVISIONS	DATE
		66

A
NORTHWEST

A'
SOUTHEAST

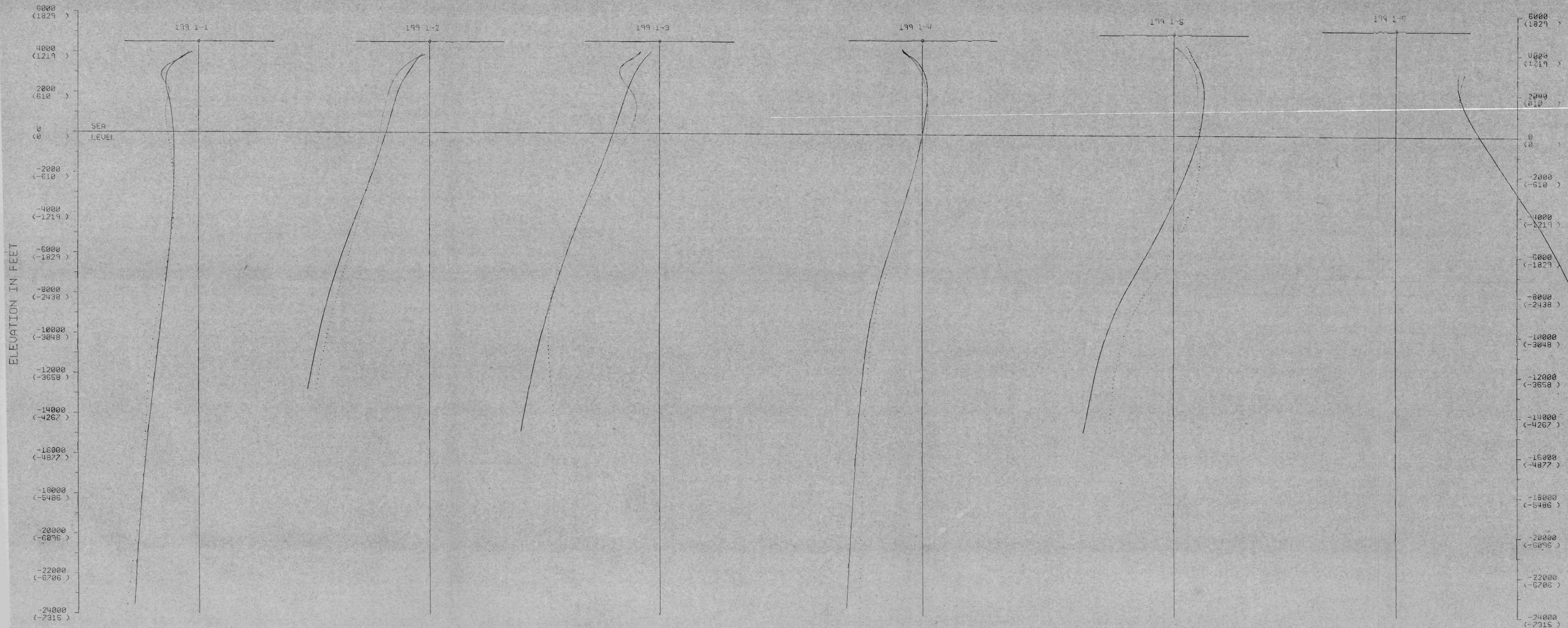

LEGEND

HORIZONTAL SCALE:



RESISTIVITY:

SITE

▽

10 Ω.m

2000'

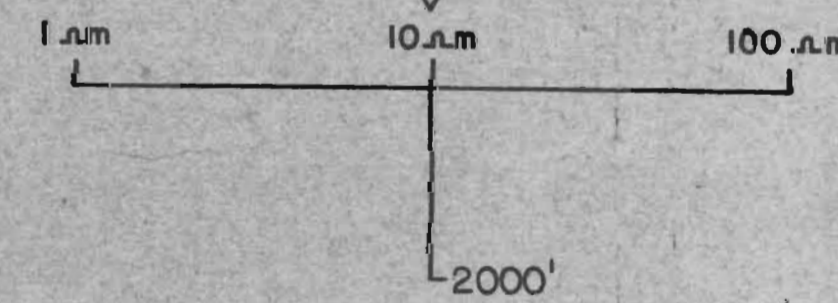

Geotronics Corp. Austin, Texas U.S.A.	
MAGNETOTELLURIC SURVEY	Survey Code
SUNEDCO-LEACH H.S., NEV.	199
CORRELATION CROSS SECTION LOG-LINEAR	
LINE A	RTM
INTERPRETER	DATE
No	REVISIONS
	7A

B
WEST

B'
EAST

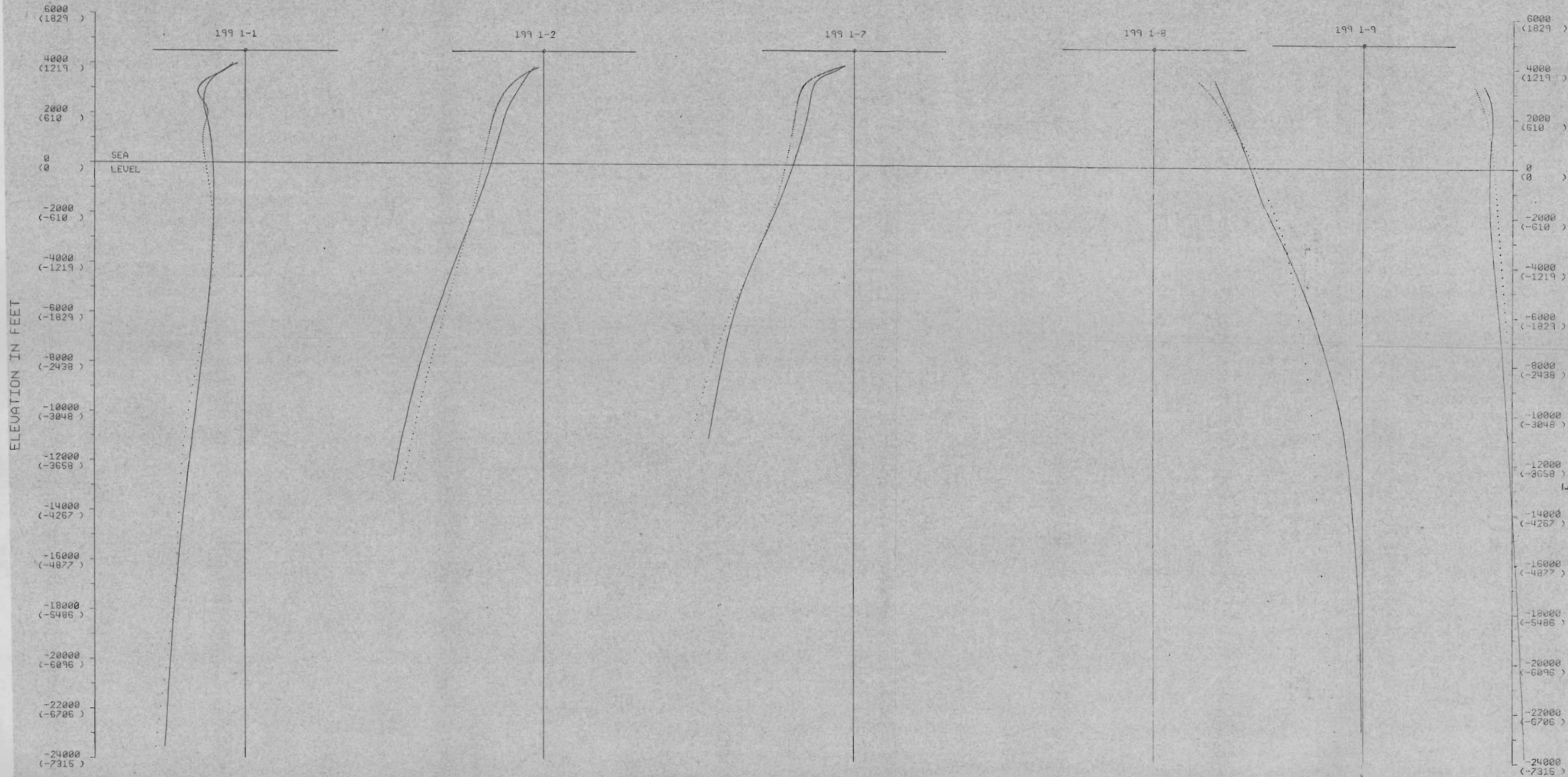

LEGEND

HORIZONTAL SCALE
 1000 2000 3000 FEET

RESISTIVITY:
 SITE
 ▽
 10 Ω.m
 100 Ω.m
 2000'

Geonics Corp. Austin, Texas U.S.A.		Survey Code
MAGNETOTELLURIC SURVEY SUNEDCO-LEACH HS., NEV.		199
TITLE CORRELATION CROSS SECTION LOG-LINEAR		
LINE B		RTM
INTERPRETER		
No.	REVISIONS	DATE
		7B

C
WEST

C'
EAST

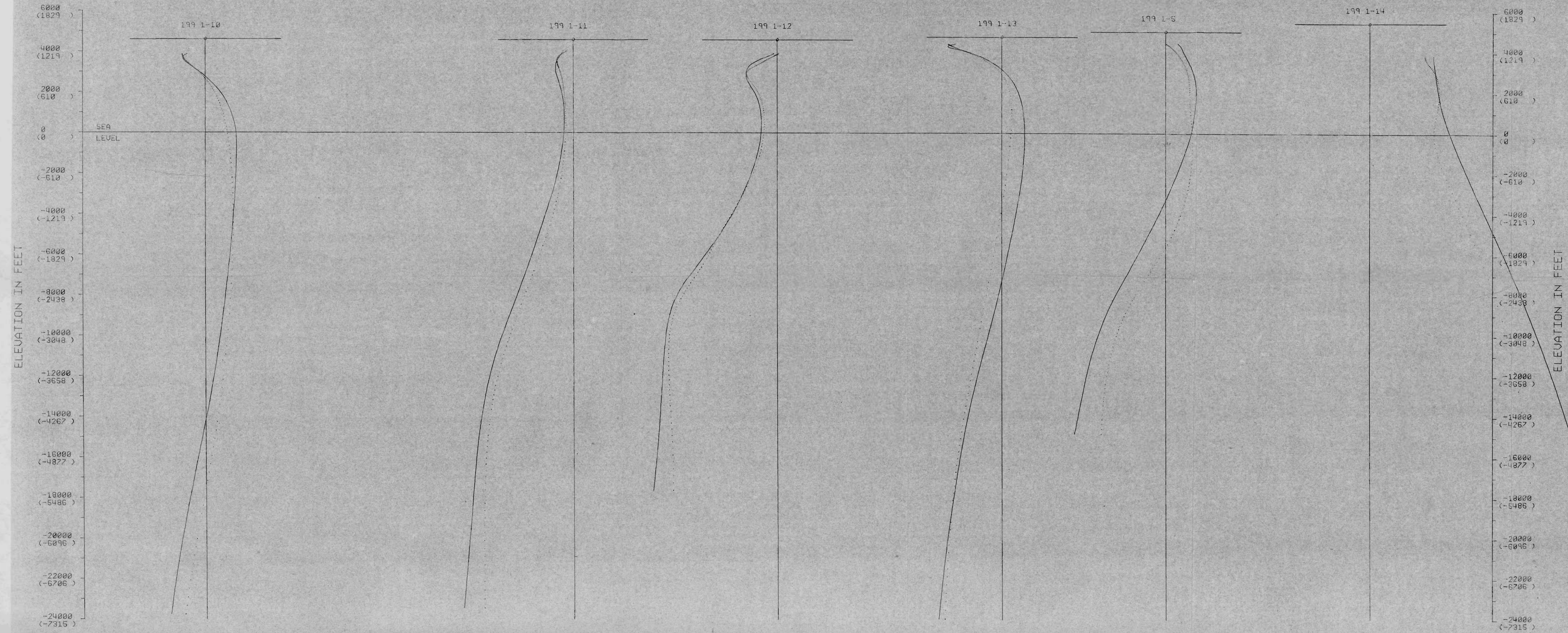

LEGEND

HORIZONTAL SCALE:
0 1000 2000 3000 FEET

RESISTIVITY:
SITE
▽
10 Ω.m
100 Ω.m
2000'

Geotronics Corp. Austin, Texas U.S.A.		Survey Code
MAGNETOTELLURIC SURVEY SUNEDCO-LEACH H.S., NEV.		199
CORRELATION CROSS SECTION LOG-LINEAR		
LINE C		RTM
INTERPRETER	REVISIONS	DATE
		7C

D
WEST

D'
EAST

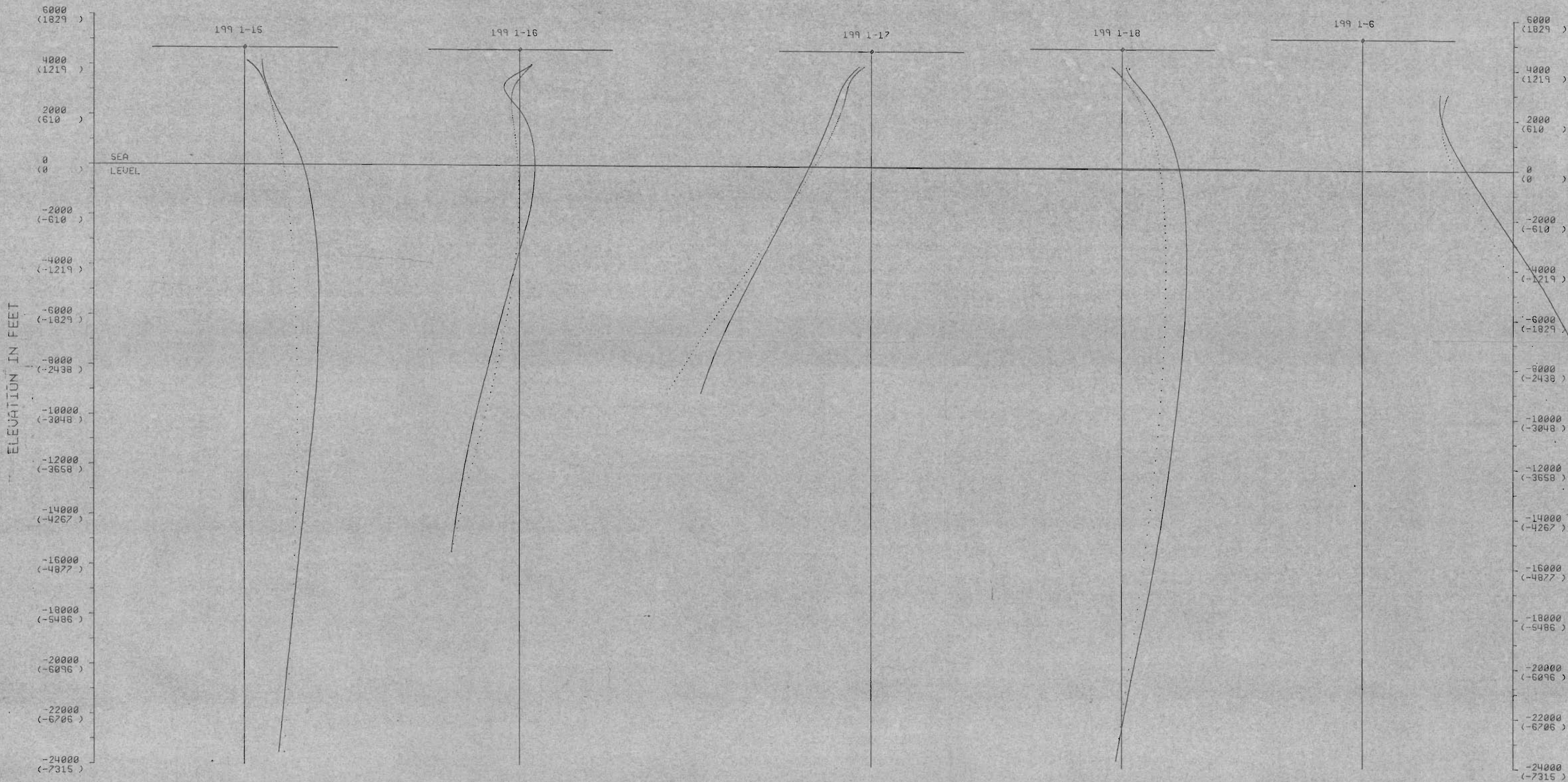

ELEVATION IN FEET

LEGEND

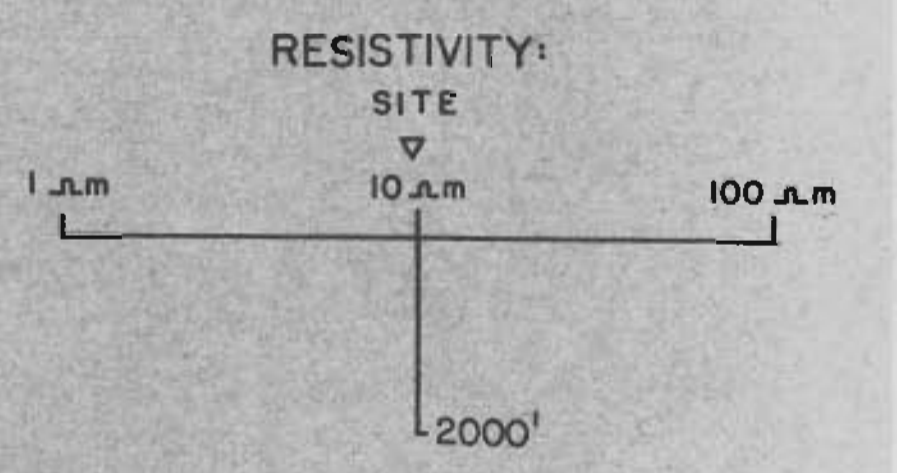
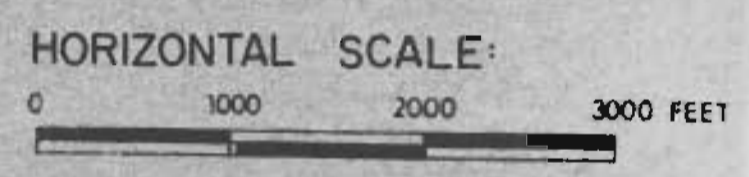

Geotronics Corp. Austin, Texas U.S.A.		Survey Code
MAGNETOTELLURIC SURVEY SUNEDCO-LEACH H.S., NEV.		199
CORRELATION CROSS SECTION LOG-LINEAR		
LINE D		RTM
INTERPRETER	REVISIONS	DATE
		7D

E
WEST

E'
EAST

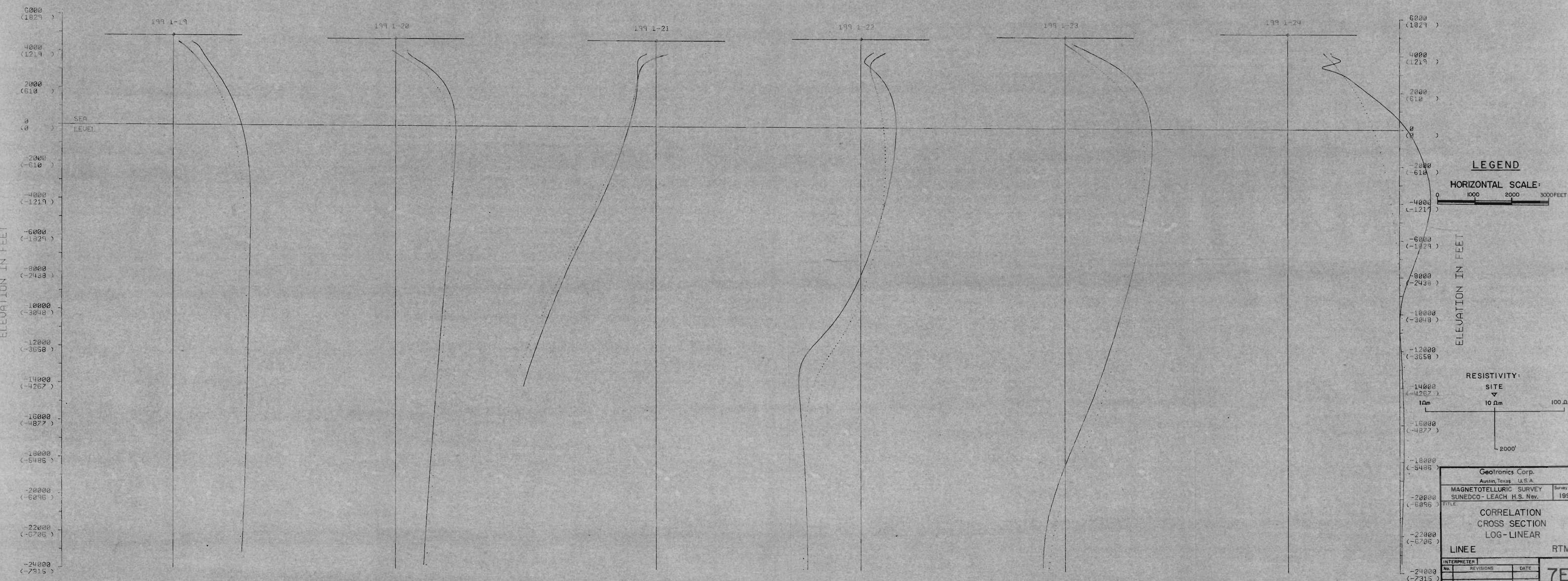

LEGEND

HORIZONTAL SCALE:
0 1000 2000 3000 FEET

RESISTIVITY:
SITE
10m 100m 2000'

Geotronics Corp. Austin, Texas U.S.A.		
MAGNETOTELLURIC SURVEY	Survey Code	199
SUNEDCO - LEACH H.S. Nev.		
CORRELATION CROSS SECTION LOG-LINEAR		
LINE E	RTM	
INTERPRETER	REVISIONS	DATE
No.		
		7E

F
WEST

F'
EAST

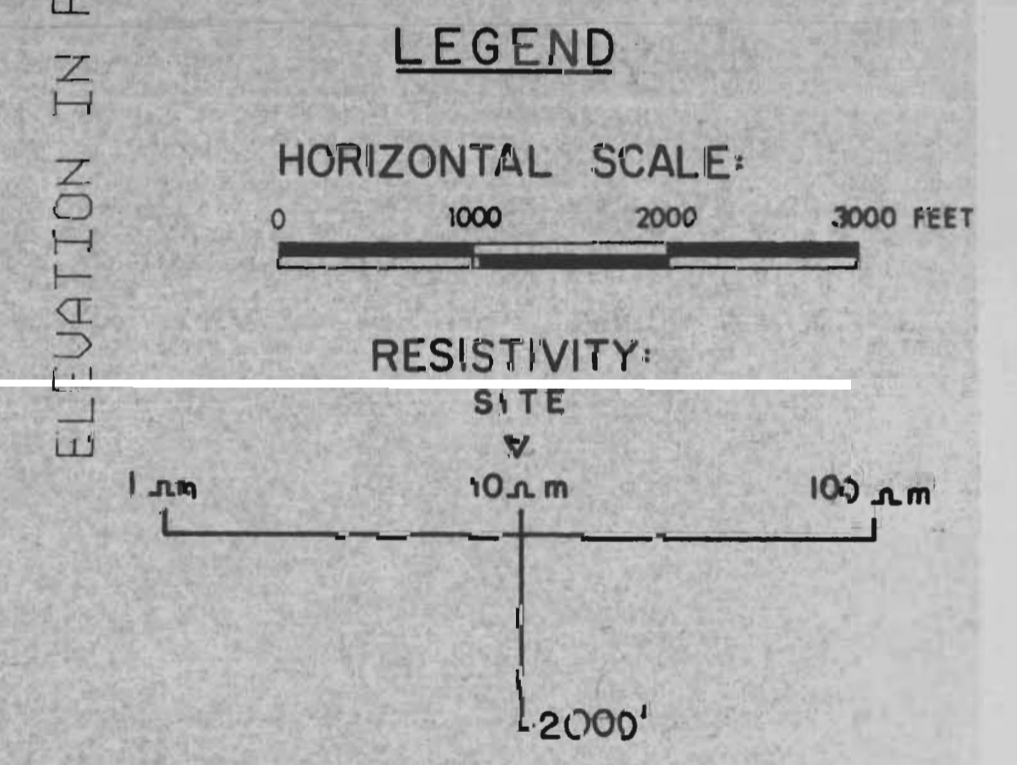
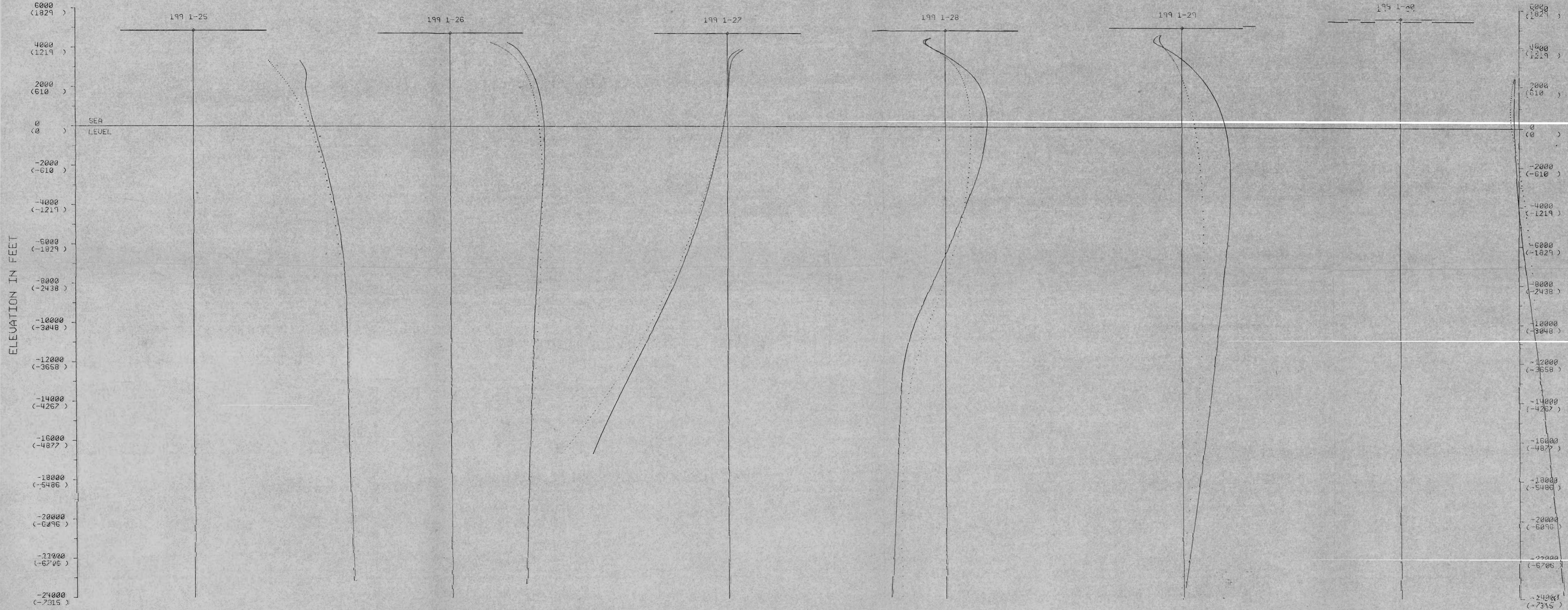

Geotronics Corp. Austin, Texas U.S.A.		
MAGNETOTELLURIC SURVEY	Survey Code	199
SUNEDCO-LEACH H.S., NEW.		
CORRELATION CROSS SECTION LOG-LINEAR		
LINE F		RTM
INTERPRETER	REVISIONS	DATE
		7F

G
WEST

G'
EAST

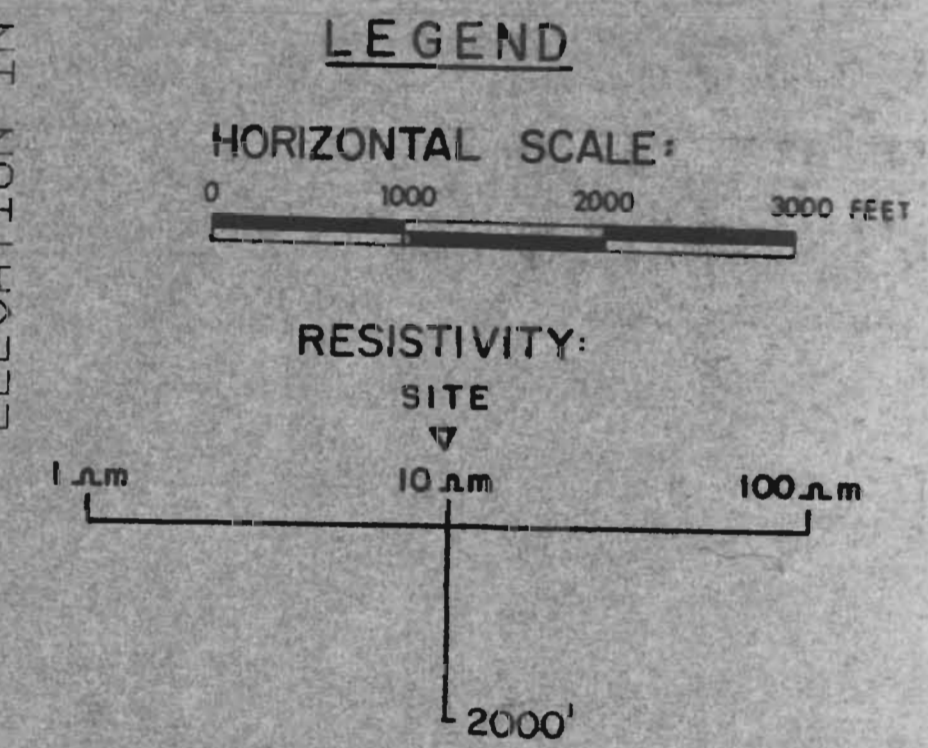
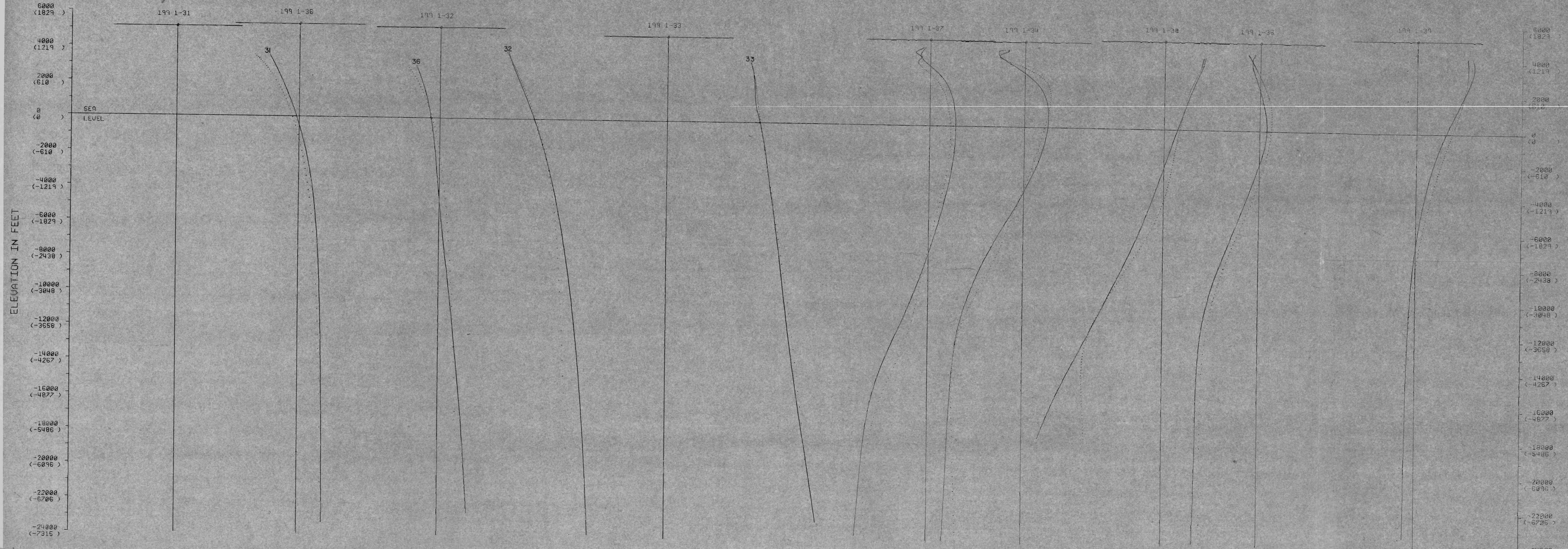

Geotronics Corp. Austin, Texas U.S.A.		
MAGNETOTELLURIC SURVEY	Survey Code	199
SUNEDCO-LEACH H.S., NEV.		
CORRELATION CROSS SECTION LOG-LINEAR		
LINE G		RTM
INTERPRETER	REVISIONS	DATE
		7G

A
NORTHWEST

A'
SOUTHEAST

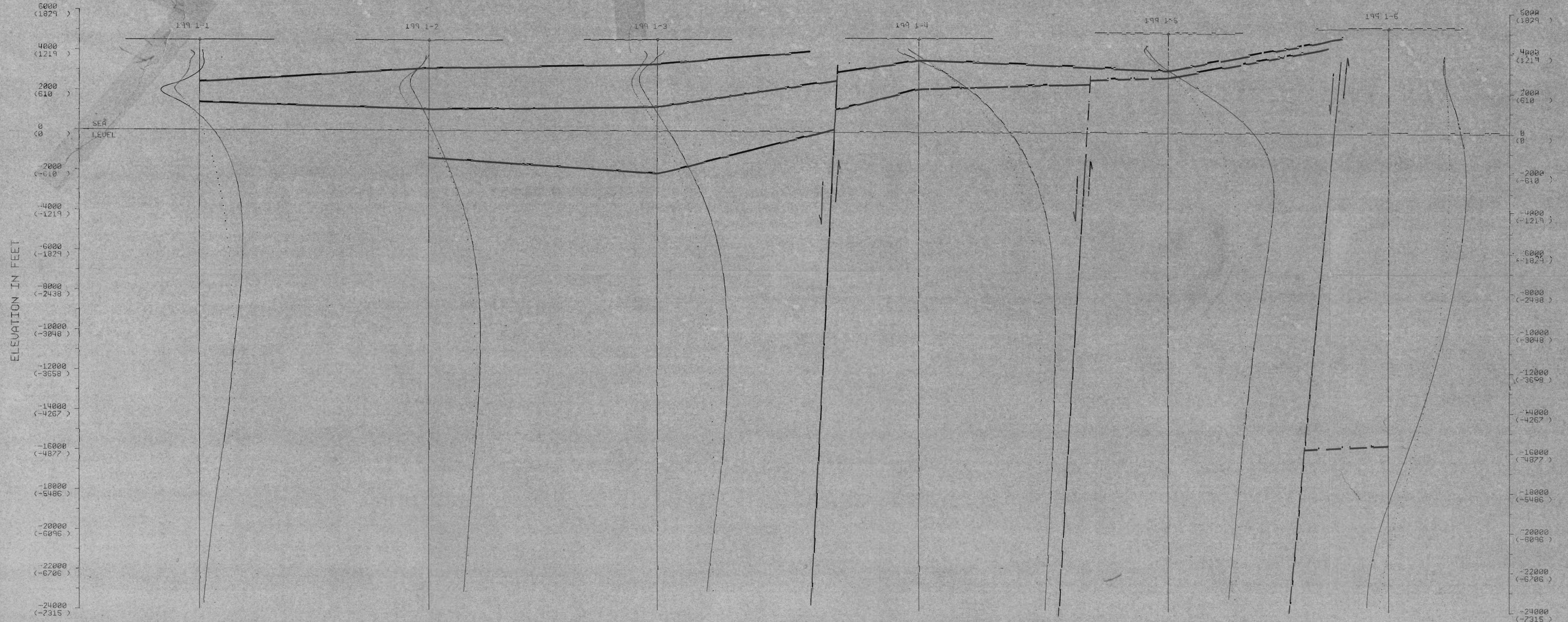

LEGEND

HORIZONTAL SCALE:



RESISTIVITY:

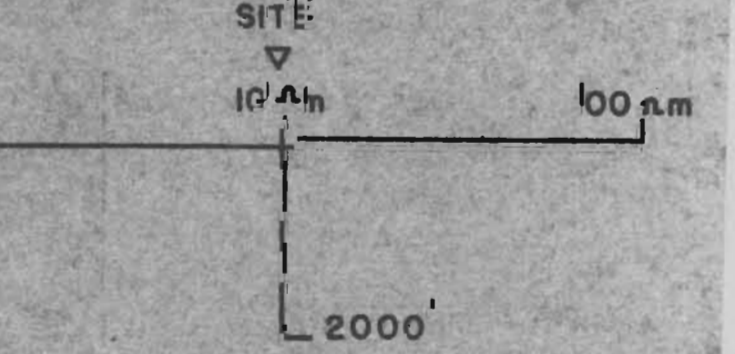

Gibsonics Corp. Austin, Texas U.S.A.		Survey Code
MAGNETOTELLURIC SURVEY SUNEDCO-LEACH H.S., Nev.		199
CORRELATION CROSS SECTION LOG-LINEAR		
LINE A		RTE
INTERPRETER	REVISIONS	DATE
		8A

B
WEST

B'
EAST

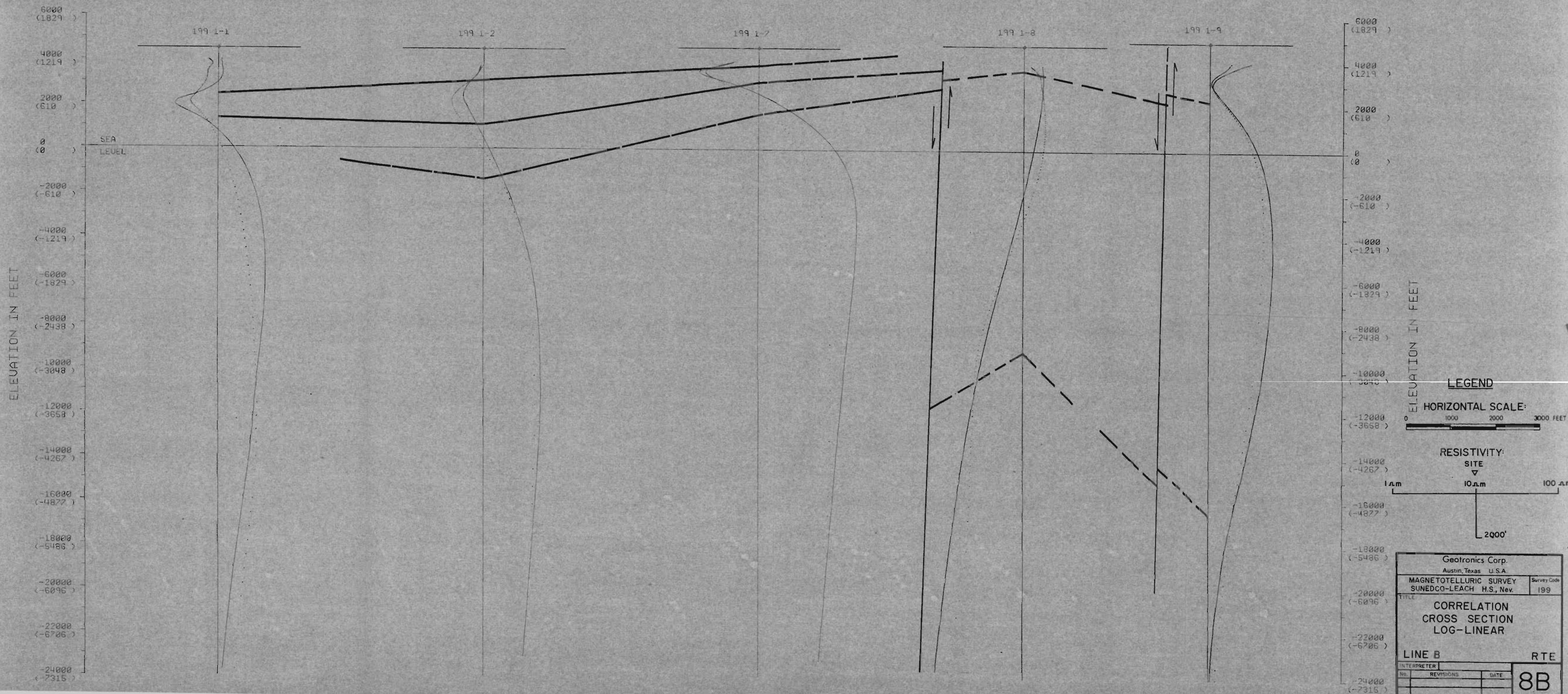

C
WEST

C'
EAST

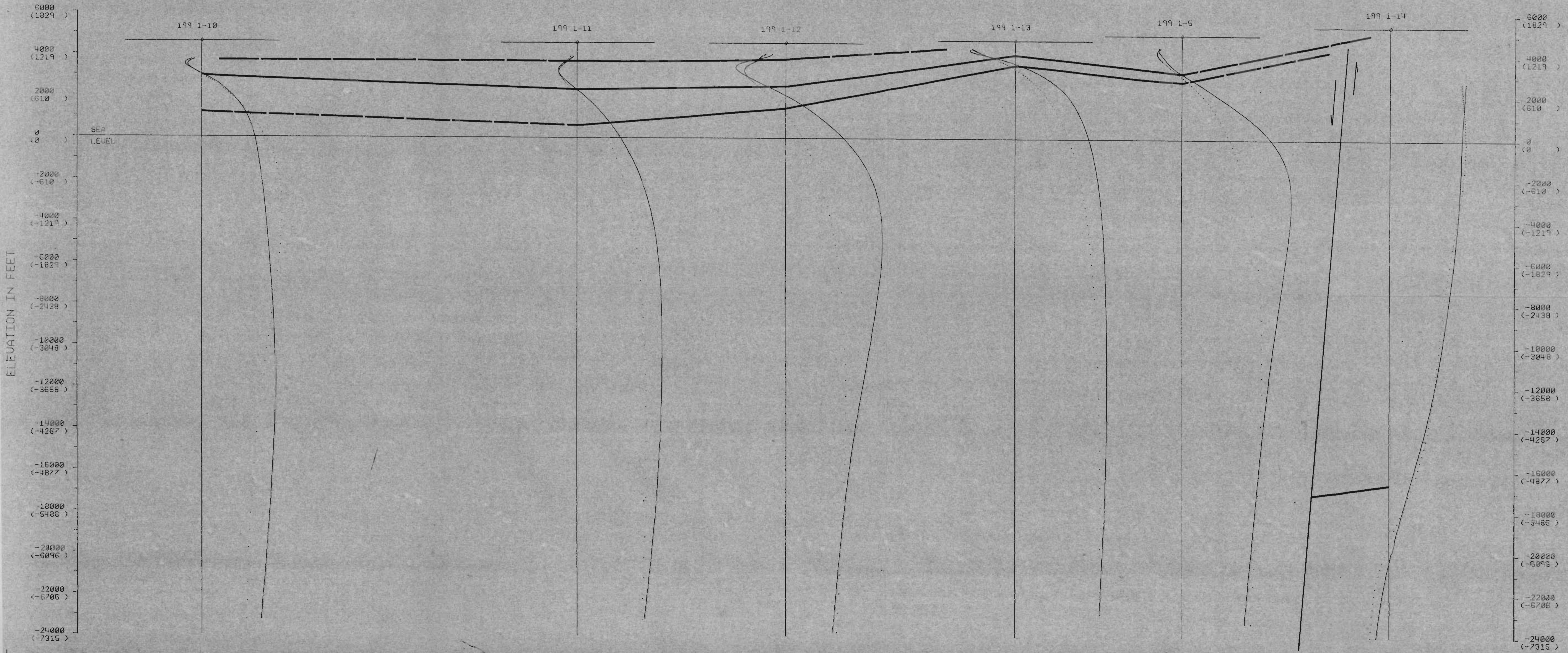

ELEVATION IN FEET

ELEVATION IN FEET

LEGEND

HORIZONTAL SCALE:

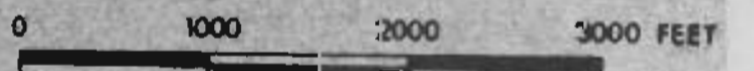

RESISTIVITY:

SITE

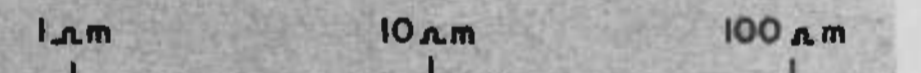
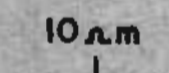

2000'

Geotronics Corp. Austin, Texas U.S.A.		
MAGNETOTELLURIC SURVEY	Survey Code	199
SUNEDCO-LEACH H.S., Nev.		
CORRELATION CROSS SECTION LOG-LINEAR		
LINE C		RTE
INTERMEIER	REVISIONS	DATE
No.		
		8C

D
WEST

D'
EAST

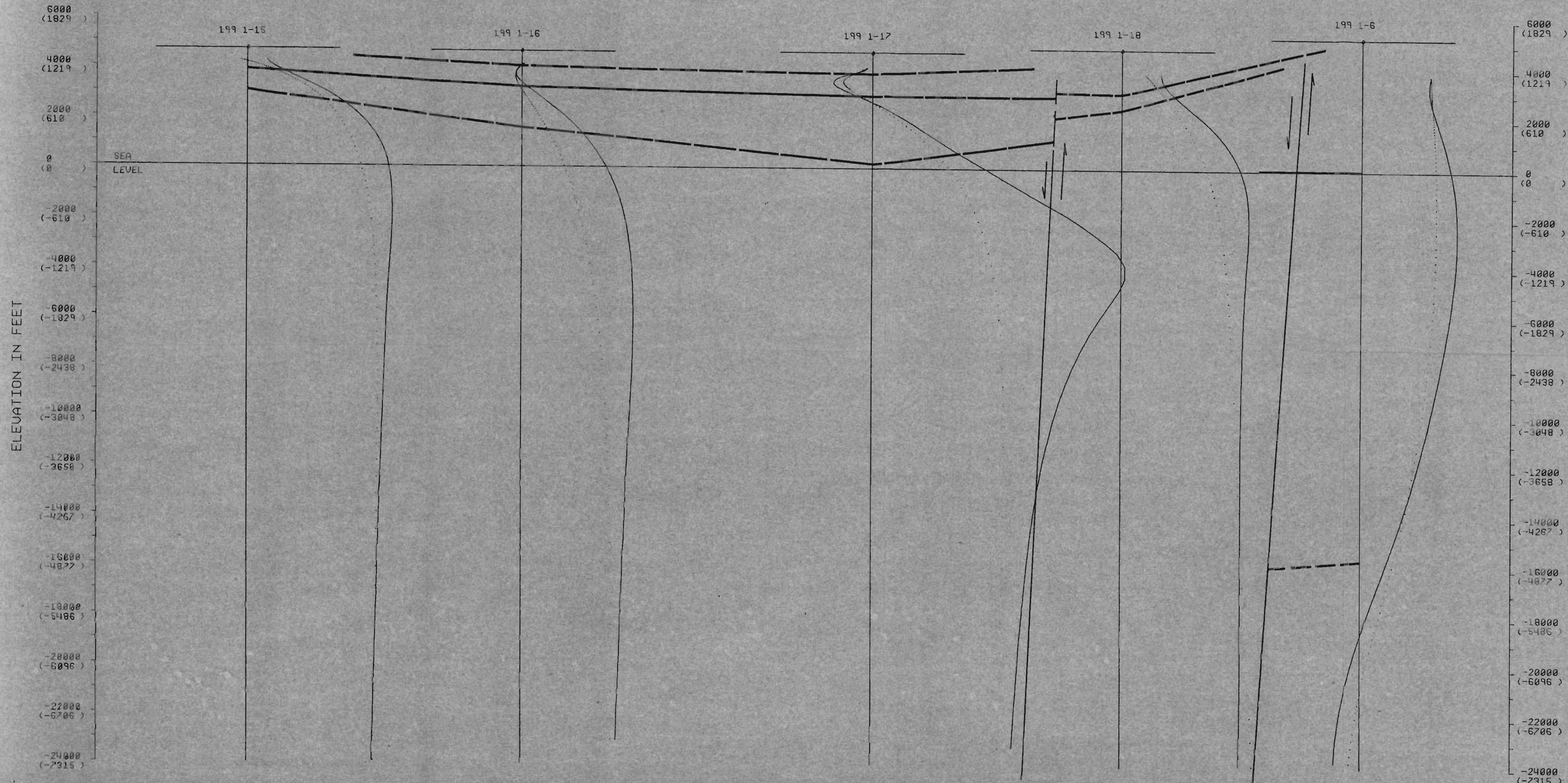

ELEVATION IN FEET

ELEVATION IN FEET

LEGEND

HORIZONTAL SCALE:



RESISTIVITY:

SITE

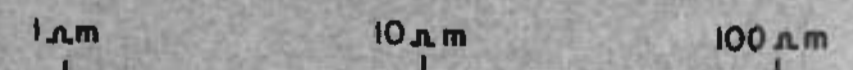

2000'

Geotronics Corp. Austin, Texas U.S.A			
MAGNETOTELLURIC SURVEY	Survey Code		
SUNEDCO-LEACH H.S., Nev.	199		
CORRELATION CROSS SECTION LOG-LINEAR			
LINE D		RTE	
INTERPRETER	DATE		8D
No.	REVISIONS		

6000 (1829)
4000 (1219)
2000 (610)
0 (0)
SEA LEVEL
-2000 (-610)
-4000 (-1219)
-6000 (-1829)
-8000 (-2438)
-10000 (-3048)
-12000 (-3658)
-14000 (-4267)
-16000 (-4877)
-18000 (-5486)
-20000 (-6096)
-22000 (-6706)
-24000 (-7315)

6000 (1829)
4000 (1219)
2000 (610)
0 (0)
-2000 (-610)
-4000 (-1219)
-6000 (-1829)
-8000 (-2438)
-10000 (-3048)
-12000 (-3658)
-14000 (-4267)
-16000 (-4877)
-18000 (-5486)
-20000 (-6096)
-22000 (-6706)
-24000 (-7315)

199 1-15

199 1-16

199 1-17

199 1-18

199 1-6

E
WEST

E
EAST

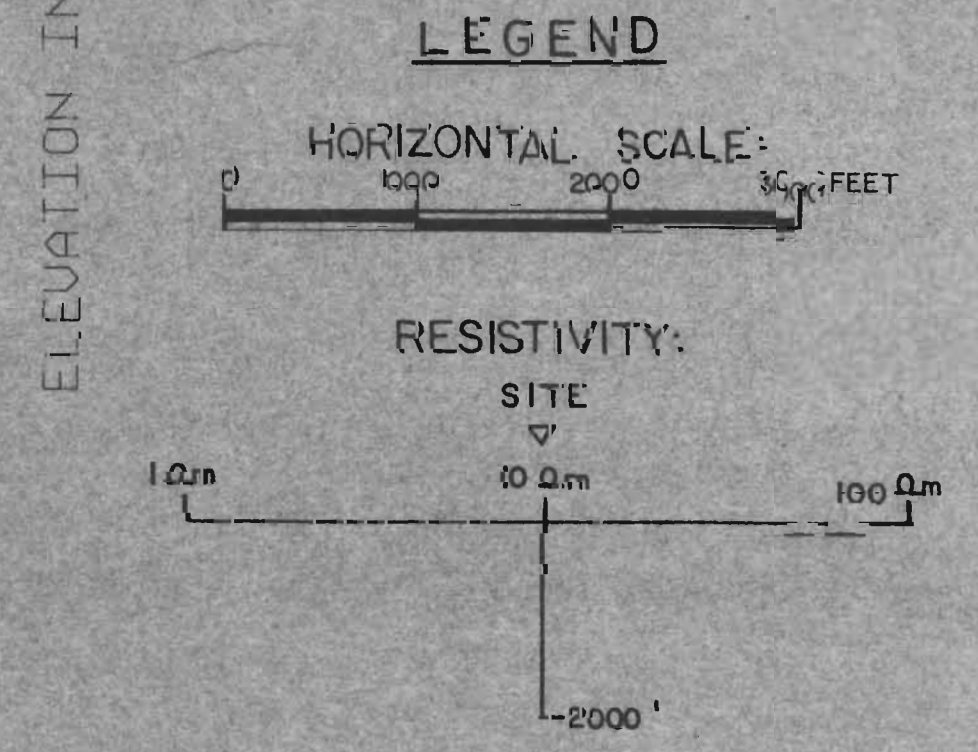
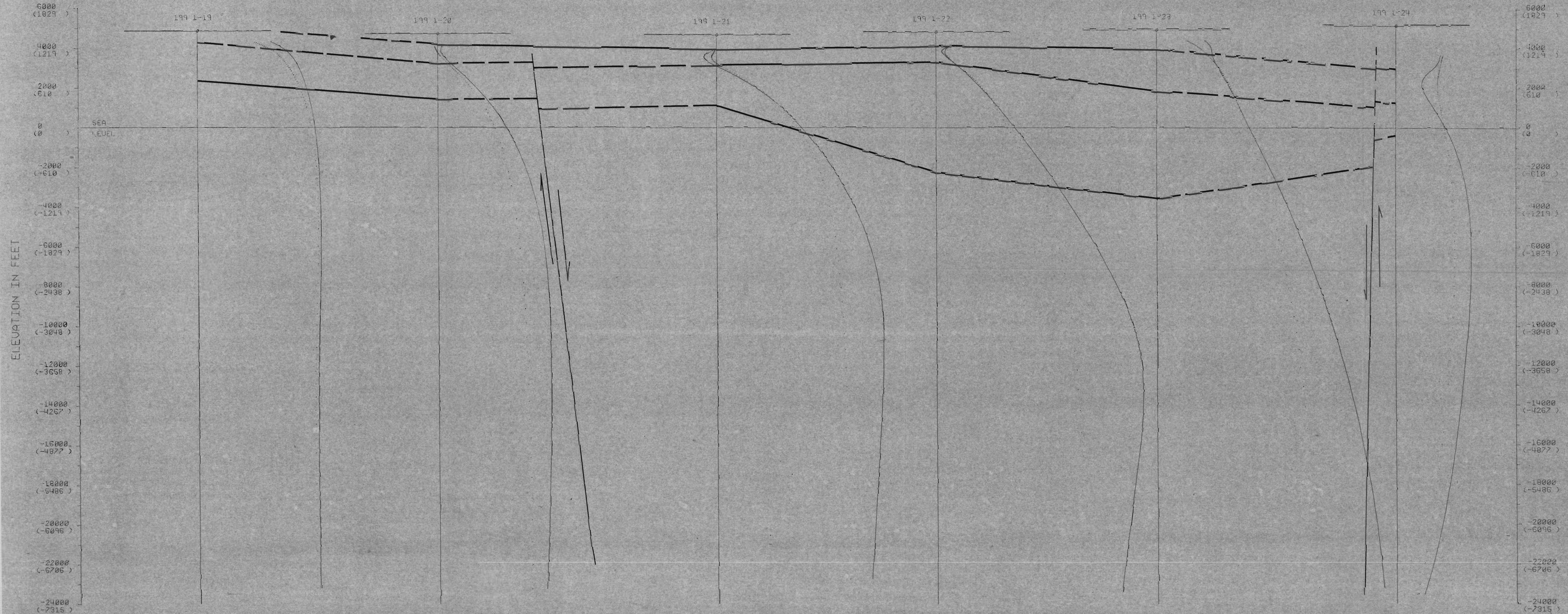

Geotronics Corp. Austin, Texas U.S.A.	
MAGNETOTELLURIC SURVEY	Survey Code
SUNEDCO-LEACH H.S., Nev	1962
TITLE CORRELATION CROSS SECTION LOG--LINEAR	
LINE#	RTE
INTERPRETER	
No.	REVISIONS
	DATE
	8E

F
WEST

F'
EAST

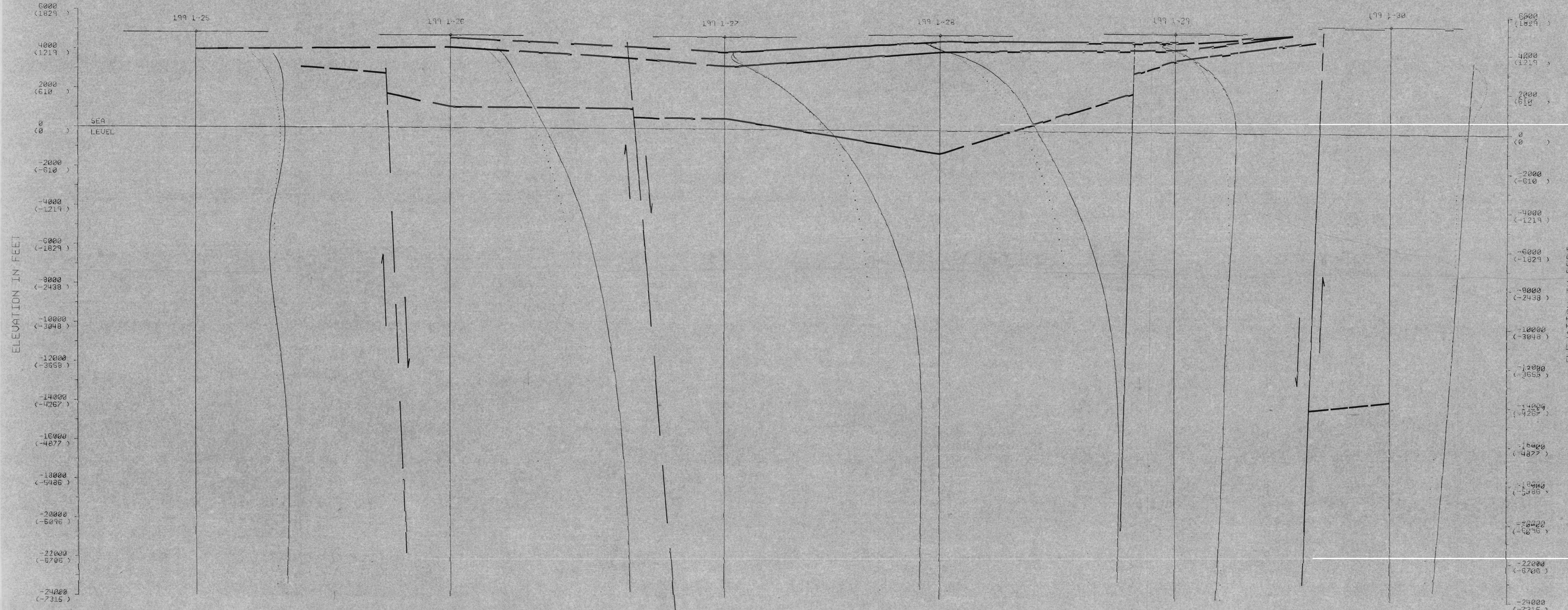

ELEVATION IN FEET

ELEVATION IN FEET

LEGEND

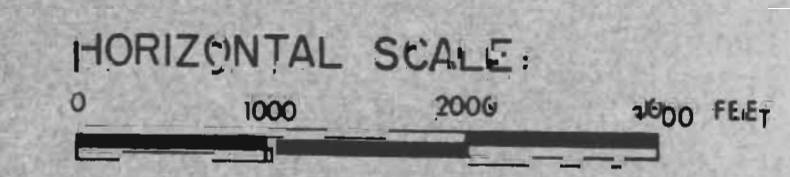

RESISTIVITY:

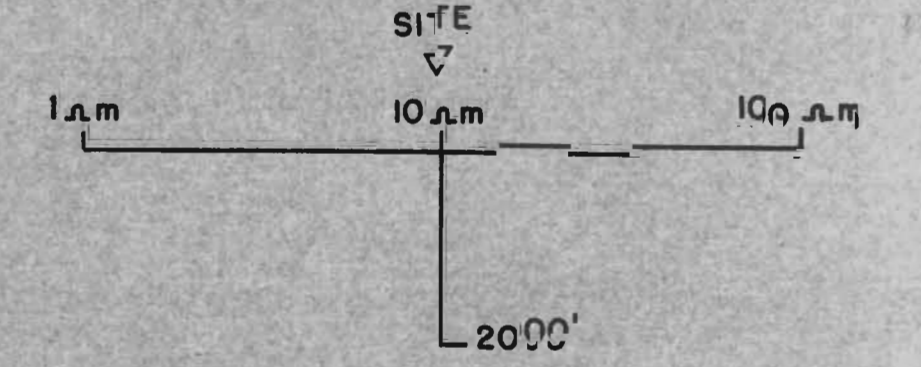

Geophysical Corp. Austin, Texas U.S.A.		Survey Code
MAGNETOTELLURIC SURVEY		199
SUNOCO-LEACH H.S., Nev.		
CORRELATION CROSS SECTION LOG-LINEAR		
LINE F		RTE
INTERPRETER	REVISIONS	DATE
		8F

G
WEST

G'
EAST

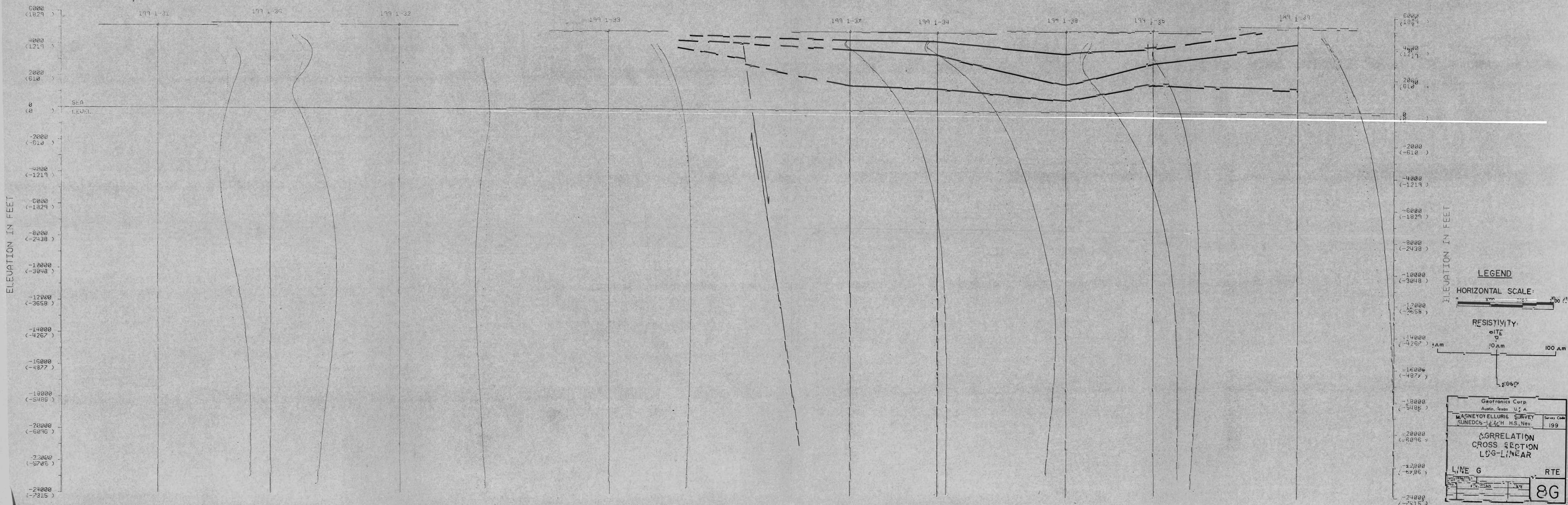

ELEVATION IN FEET

ELEVATION IN FEET

LEGEND

HORIZONTAL SCALE:

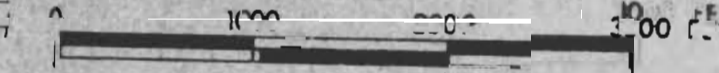

RESISTIVITY:

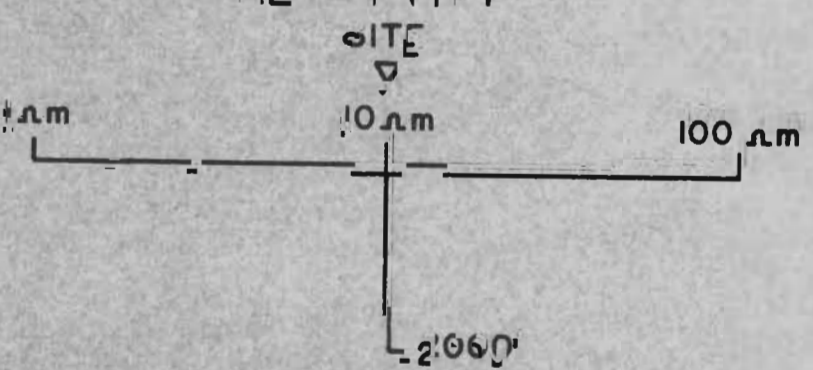

Geotronics Corp. Austin, Texas U.S.A.	
MAGNETOTELLURIC SURVEY	Survey Code
SUNEDCS-LEACH H.S., Nev.	199
CORRELATION CROSS SECTION LOG-LINEAR	
LINE G	RTE
8G	

A
NORTHWEST

A'
SOUTHEAST

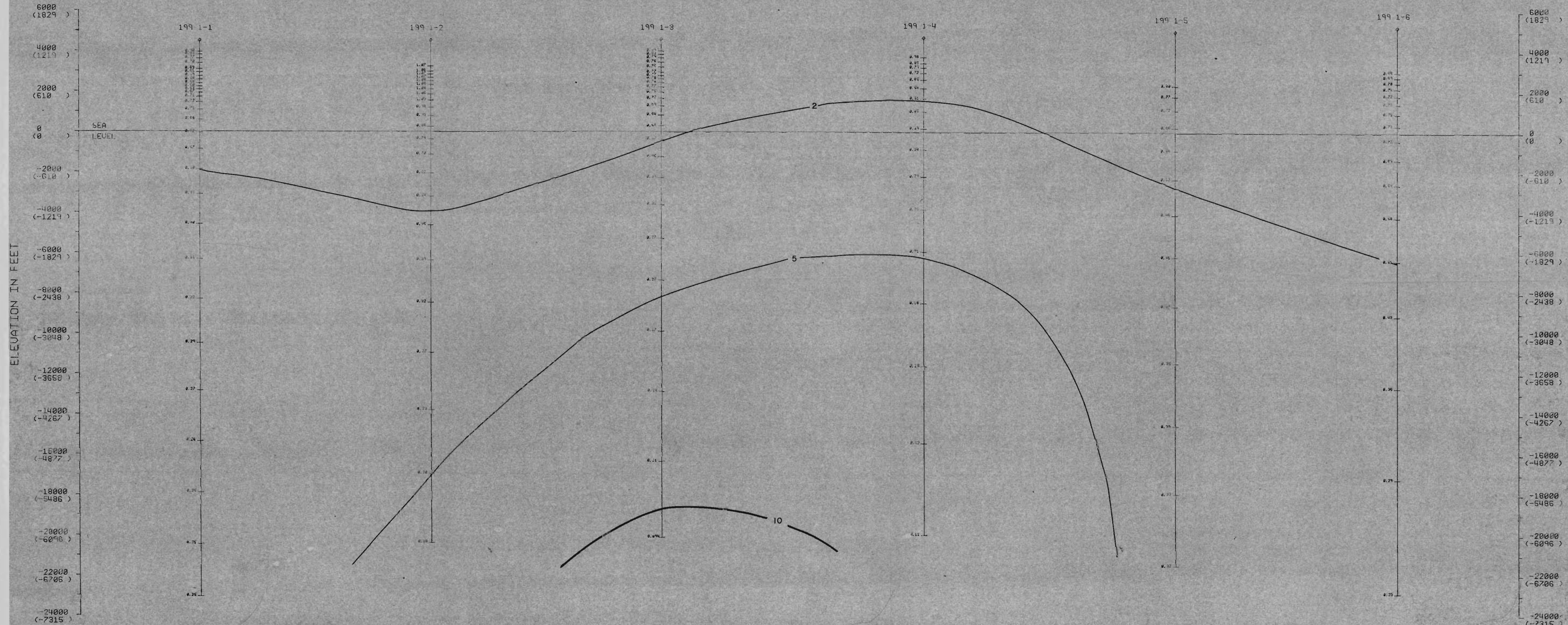

LEGEND
HORIZONTAL SCALE:
0 1000 2000 3000 FEET

AF: RTM/RTE
OR
RTE/RTM
CONTOUR VALUES
2,5,10 X 10^N

Geotronics Corp. Austin, Texas U.S.A.	
MAGNETOTELLURIC SURVEY	Survey Code
SUNEDCO-LEACH H.S., Nev.	199
ANISOTROPY FACTOR CROSS SECTION	
LINE A	
INTERPRETER	DATE
No. REVISIONS	9A

B
WEST

B'
EAST

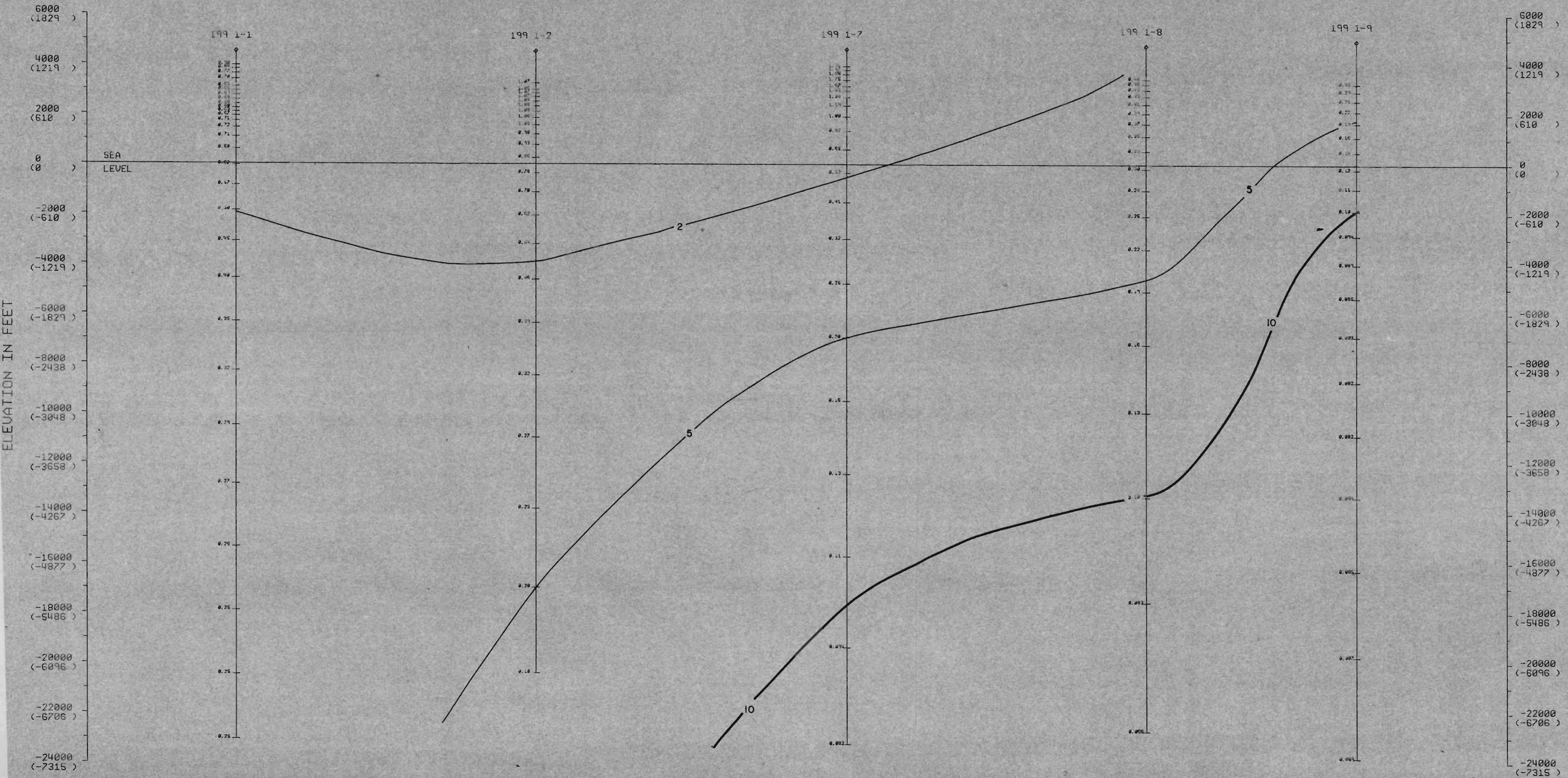

ELEVATION IN FEET

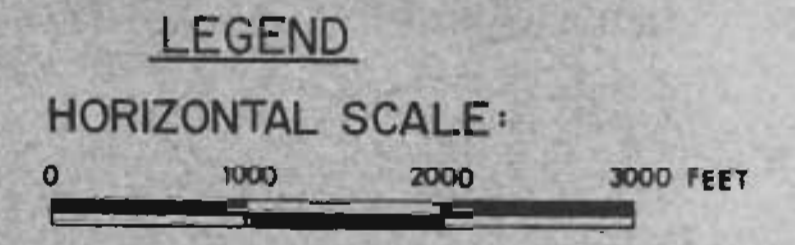

AF: RTM/RTE
OR
RTE/RTM
CONTOUR VALUES
2,5,10 X 10^N

Geonics Corp. Austin, Texas U.S.A.	
MAGNETOTELLURIC SURVEY	Survey Code
SUNEDCO-LEACH H.S., Nev.,	199
ANISOTROPY FACTOR CROSS SECTION	
LINE B	
INTERPRETER	DATE
No.	REVISIONS
	9B

C
WEST

C'
EAST

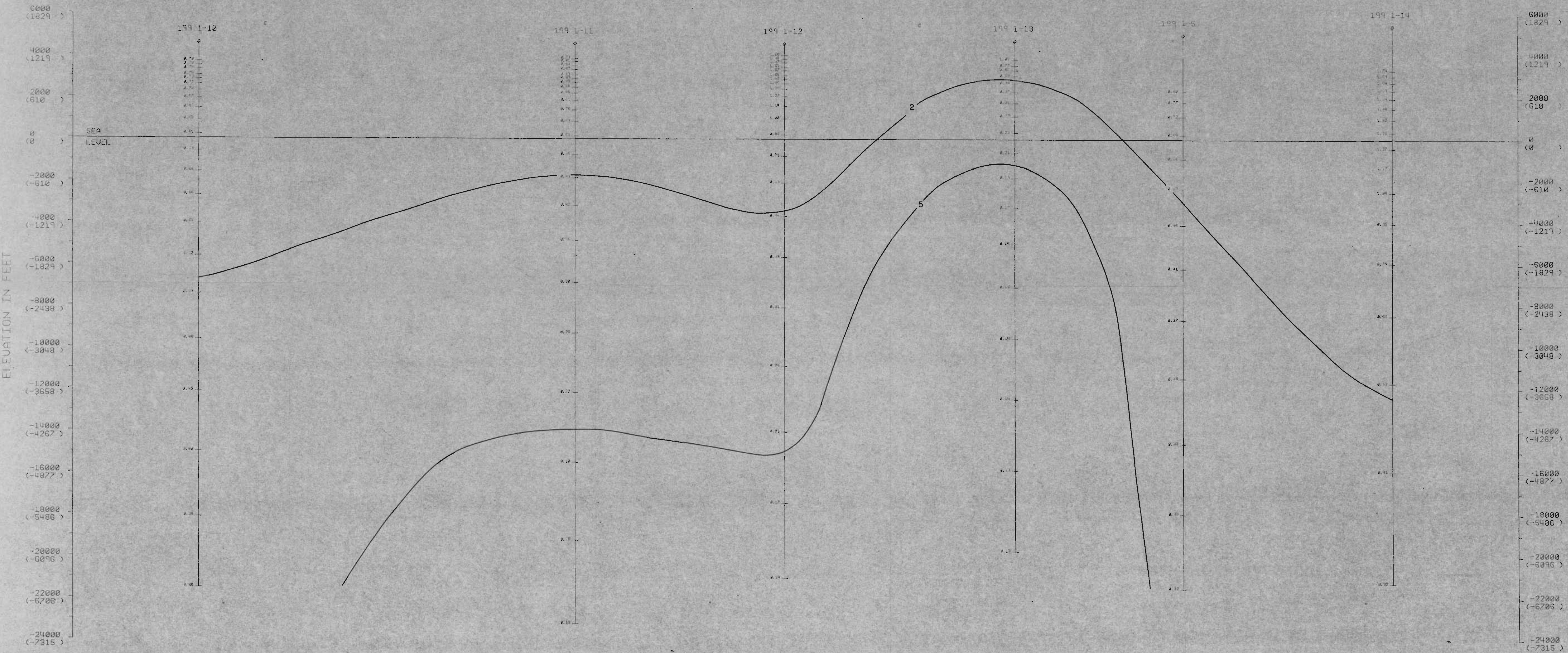

ELEVATION IN FEET

LEGEND
 HORIZONTAL SCALE:
 0 1000 2000 3000 FEET

AF: RTM/RTE
 OR
 RTE/RTM

CONTOUR VALUES
 2,5,10 X 10^N

Geotronics Corp. Austin, Texas U.S.A.		
MAGNETOTELLURIC SURVEY SUNEDCO-LEACH H.S., Nev.		Survey Code 199
ANISOTROPY FACTOR CROSS SECTION		
LINE C		
INTERPRETER	REVISIONS	DATE
		9C

D
WEST

D'
EAST

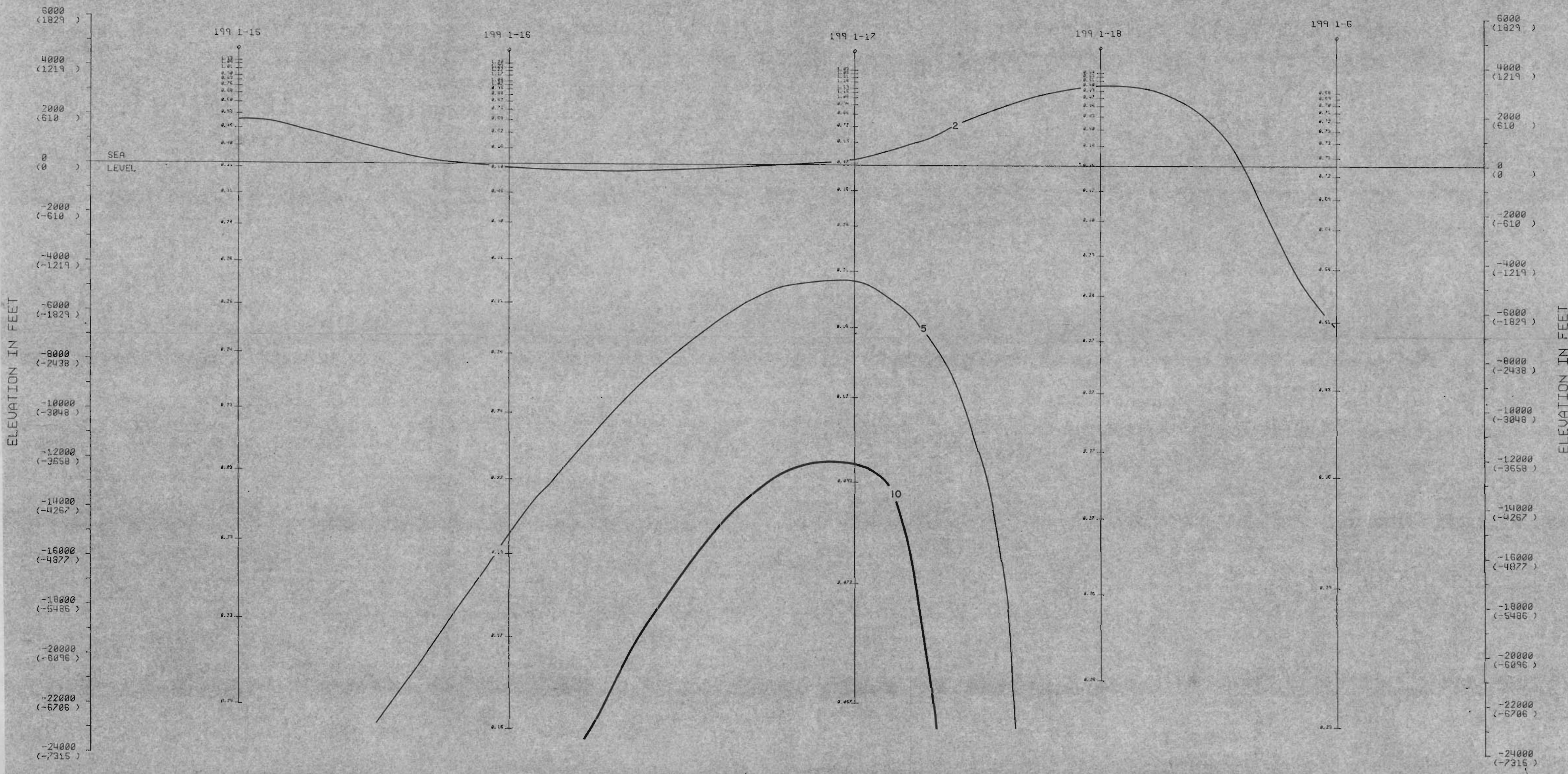

ELEVATION IN FEET

LEGEND

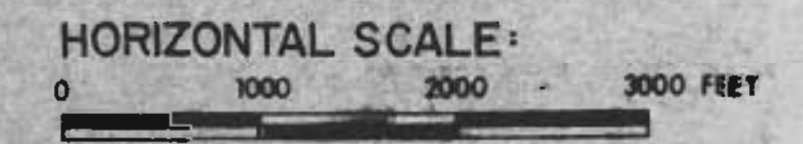

AF: RTM/RTE
OR
RTE/RTM
CONTOUR VALUES
2,5,10 X 10^N

Geomatics Corp. Austin, Texas U.S.A.		Survey Code
MAGNETOTELLURIC SURVEY		199
SUNEDCO-LEACH H.S., Nev.		
ANISOTROPY FACTOR CROSS SECTION		
LINE D		
INTERPRETER	REVISIONS	DATE
		9D

E
WEST

E'
EAST

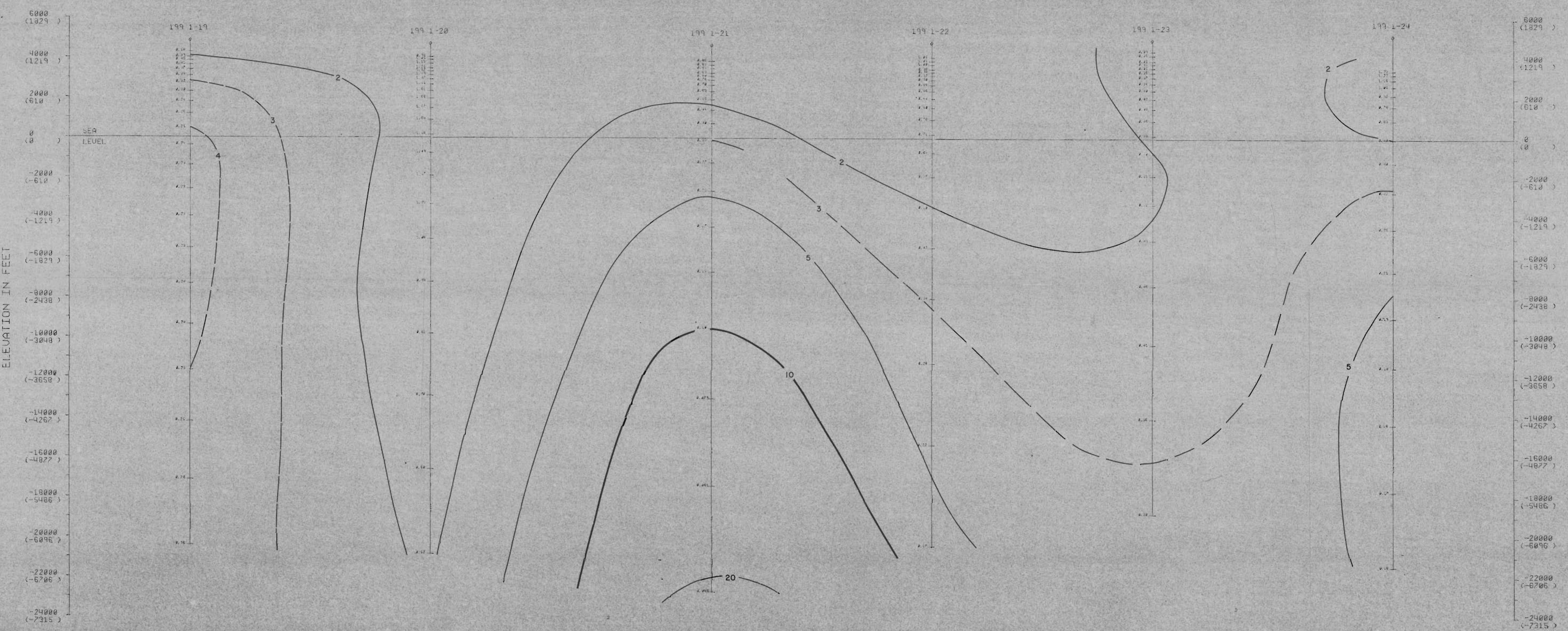

ELEVATION IN FEET

LEGEND
 HORIZONTAL SCALE:
 0 1000 2000 3000 FEET

AF: RTM/RTE
 OR
 RTE/RTM

CONTOUR VALUES
 2, 5, 10 X 10^N

Geotronics Corp. Austin, Texas U.S.A.		
MAGNETOTELLURIC SURVEY		Survey Code
SUNEDCO-LEACH H.S., Nev.		199
ANISOTROPY FACTOR CROSS SECTION		
LINE E		
INTERPRETER	REVISIONS	DATE
		9E

F
WEST

F
EAST

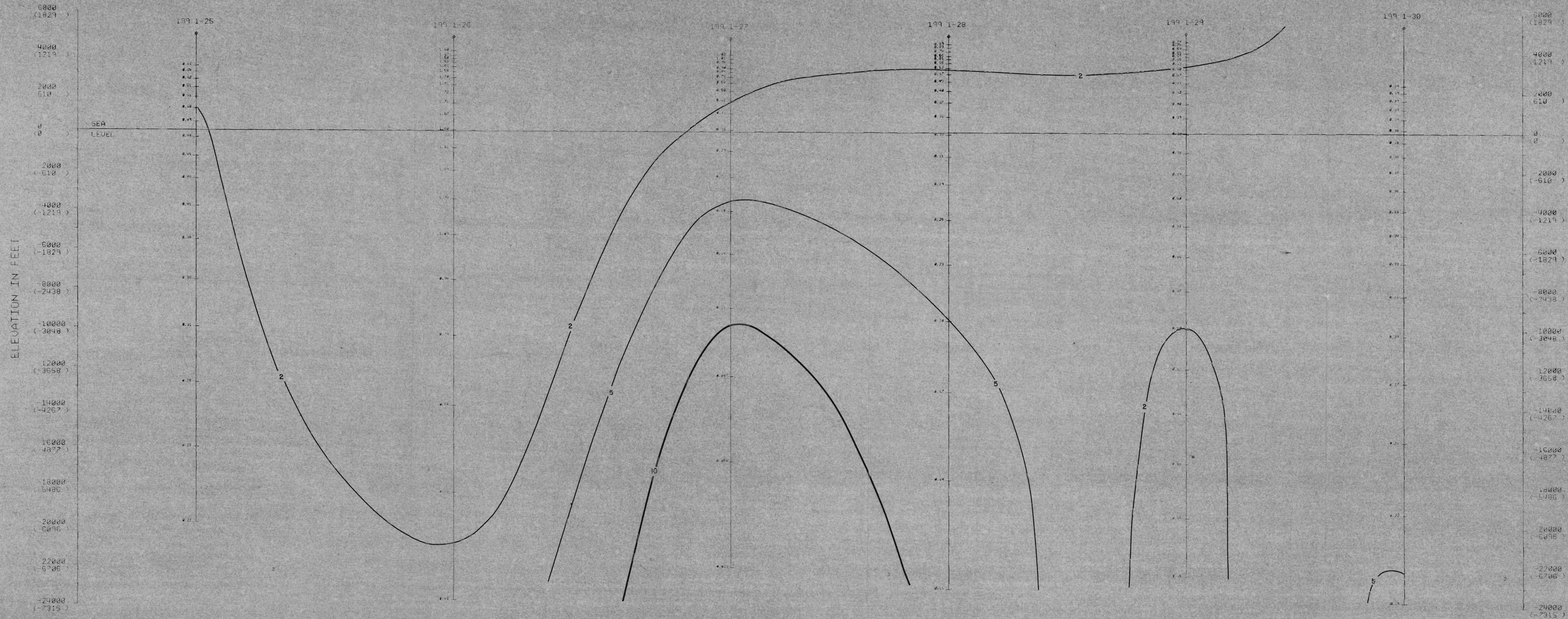

LEGEND
 HORIZONTAL SCALE:
 0 1000 2000 3000
 (FEET)
 AF: RTM/RTE
 OR
 RTE/RTM
 CONTOUR VALUES
 2,5,10 x 10^M

Geotronics Corp Austin, Texas U.S.A.	
MAGNETOTELLURIC SURVEY	Survey Code
SUNEDCO-LEACH H.S., Nev.	139
ANISOTROPY FACTOR CROSS SECTION	
LINE F	
PARAMETER	DATE
1	
2	
3	
4	
5	
6	
7	
8	
9	
10	
11	
12	
13	
14	
15	
16	
17	
18	
19	
20	
21	
22	
23	
24	
25	
26	
27	
28	
29	
30	
31	
32	
33	
34	
35	
36	
37	
38	
39	
40	
41	
42	
43	
44	
45	
46	
47	
48	
49	
50	
51	
52	
53	
54	
55	
56	
57	
58	
59	
60	
61	
62	
63	
64	
65	
66	
67	
68	
69	
70	
71	
72	
73	
74	
75	
76	
77	
78	
79	
80	
81	
82	
83	
84	
85	
86	
87	
88	
89	
90	
91	
92	
93	
94	
95	
96	
97	
98	
99	
100	

9F

G WEST

G' EAST

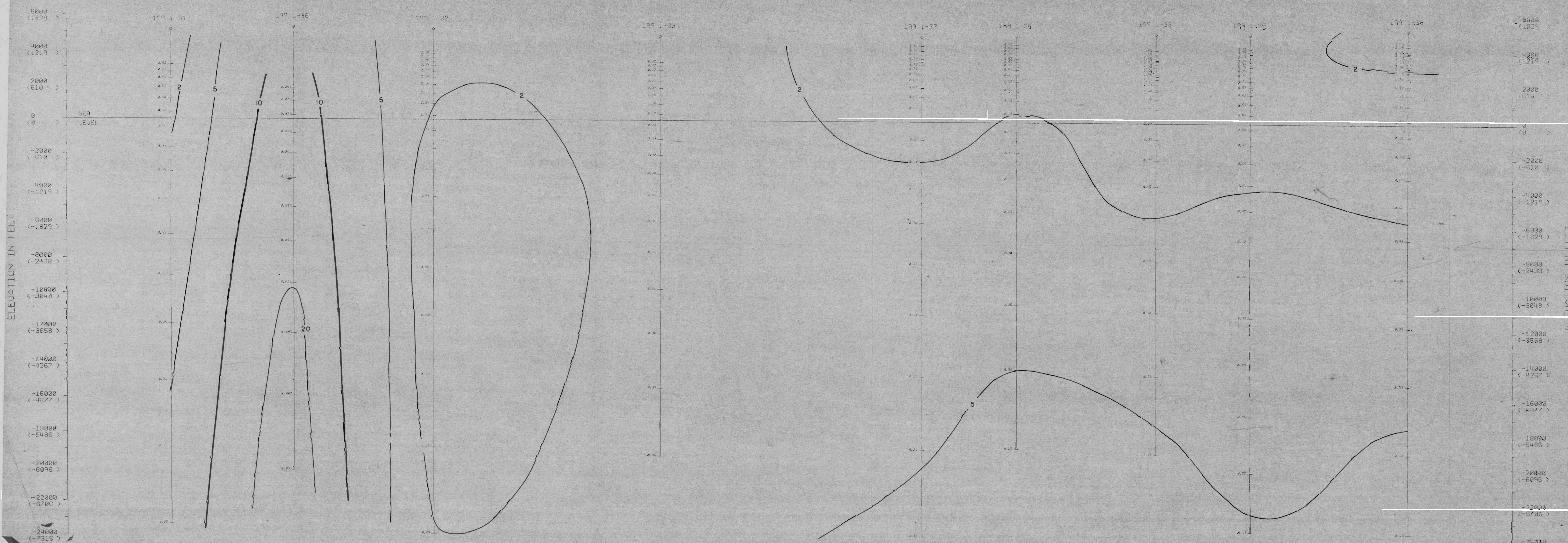

LEGEND

HORIZONTAL SCALE:
0 1000 2000 3000 FEET

AF: RTM/RTE
OR
RTE/RTM
CONTOUR VALUES
2,5,10 X 10ⁿ

Geotronics Corp. Austin, Texas U.S.A.	
MAGNETOTELLURIC SURVEY	Survey Code
SUNEDCO-LEACH H.S., Nev., 199	
ANISOTROPY FACTOR CROSS SECTION	
LINE G	
INTERPRETER	DATE
No.	REV. NO.
	96

NORTHWEST

A'
SOUTHEAST

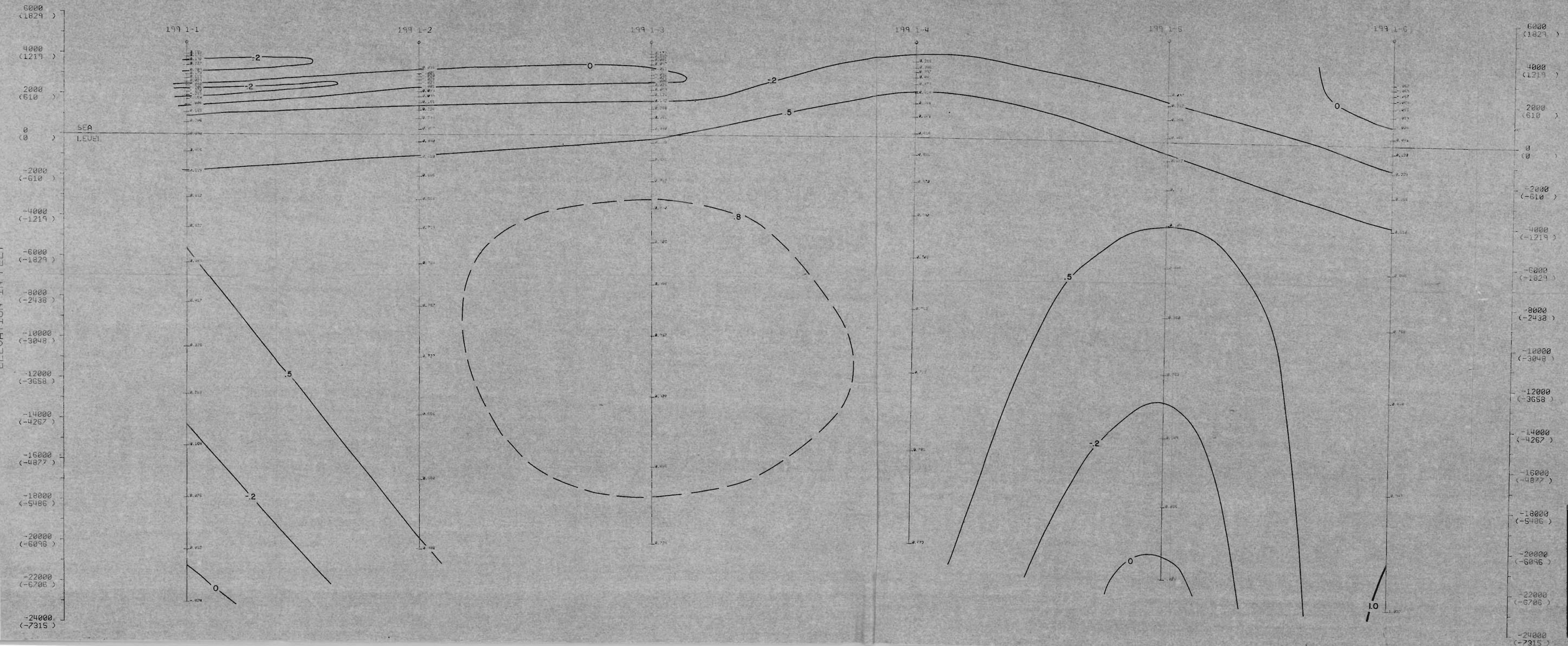

LEGEND
 HORIZONTAL SCALE
 0 1000 2000 3000 FEET

AS=0: ONE DIMENSIONAL
 AS>0: RESISTIVE ANOMALY
 AS<0: CONDUCTIVE ANOMALY
 CONTOUR VALUES:
 ±0, 2, .5, 10 X 10^N

Geotronics Corp. Austin, Texas U.S.A	
MAGNETOTELLURIC SURVEY SUNEDCO-LEACH H.S., NEV.	Survey Code 199
ANISOTROPY SENSE CROSS SECTION	
LINE A	
INTERPRETER	DATE
No.	REVISIONS
	IOA

B
WEST

D
EAST

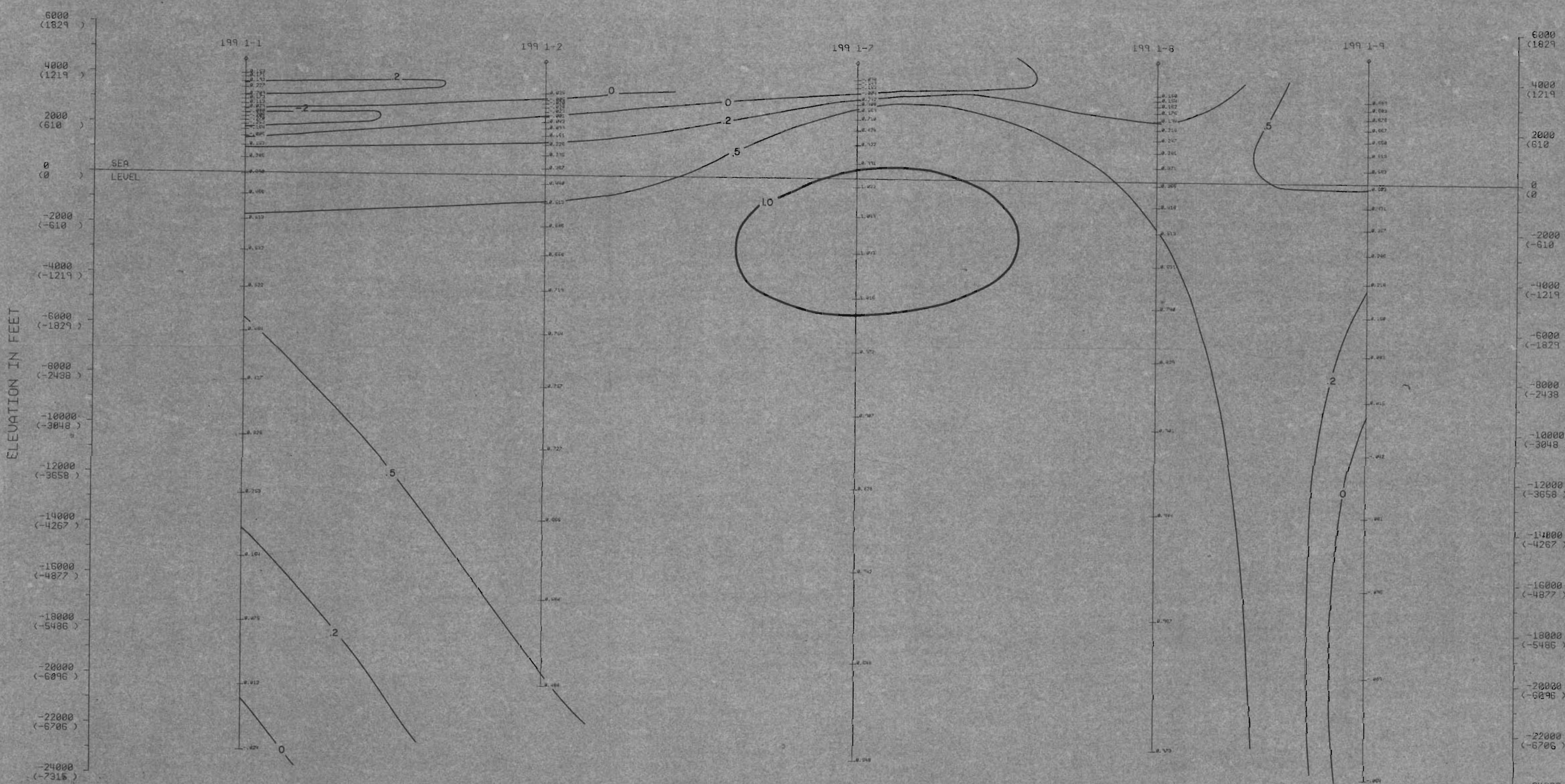

ELEVATION IN FEET

6000 (1829)
 4000 (1219)
 2000 (610)
 0 (0)
 -2000 (-610)
 -4000 (-1219)
 -6000 (-1829)
 -8000 (-2438)
 -10000 (-3048)
 -12000 (-3658)
 -14000 (-4267)
 -16000 (-4877)
 -18000 (-5486)
 -20000 (-6096)
 -22000 (-6706)
 -24000 (-7315)

LEGEND
 HORIZONTAL SCALE
 0 1000 2000 3000 FEET

AS = 0 : ONE DIMENSIONAL
 AS > 0 : RESISTIVE ANOMALY
 AS < 0 : CONDUCTIVE ANOMALY

CONTOUR VALUES:
 *0, 2, .5, 1.0 x 10^N

Geotronics Corp. Aubin, Texas U.S.A.	
MAGNETOTELLURIC SURVEY	Survey Code
SUNEDCO-LEACH H.S., NEV.	199
ANISOTROPY SENSE CROSS SECTION	
LINE B	
INTERPRETER	DATE
No. REVISIONS	DATE
	IOB

C
WEST

C'
EAST

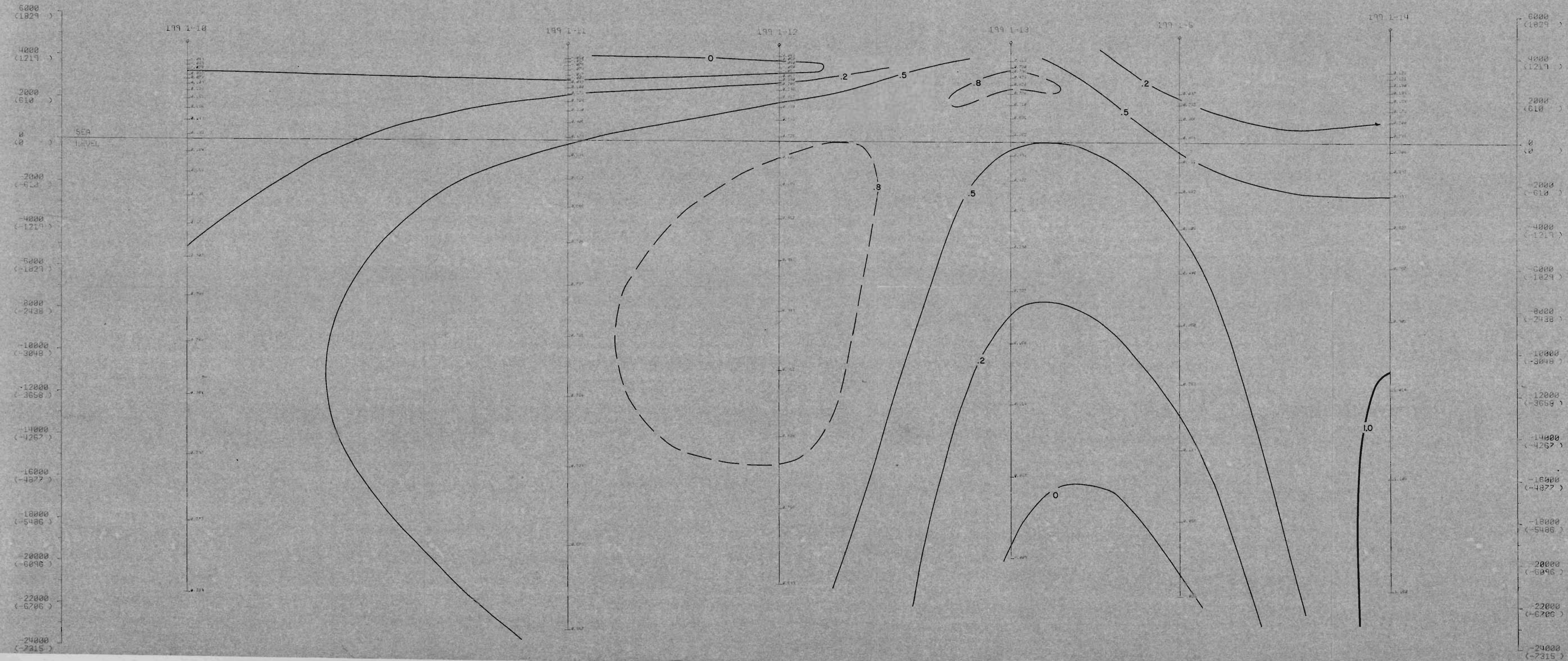

LEGEND
 HORIZONTAL SCALE
 0 1000 2000 3000 FEET

AS=0: ONE DIMENSIONAL
 AS>0: RESISTIVE ANOMALY
 AS<0: CONDUCTIVE ANOMALY
 CONTOUR VALUES:
 ±0.2, .5, 1.0 X 10

Geotronics Corp. Austin, Texas U.S.A.		
MAGNETOTELLURIC SURVEY	Survey Code	199
SUNEDCO-LEACH H.S., NEV.		
ANISOTROPY SENSE CROSS SECTION		
LINE C		
INTERPRETER	REVISIONS	DATE
		IOC

D
WEST

D'
EAST

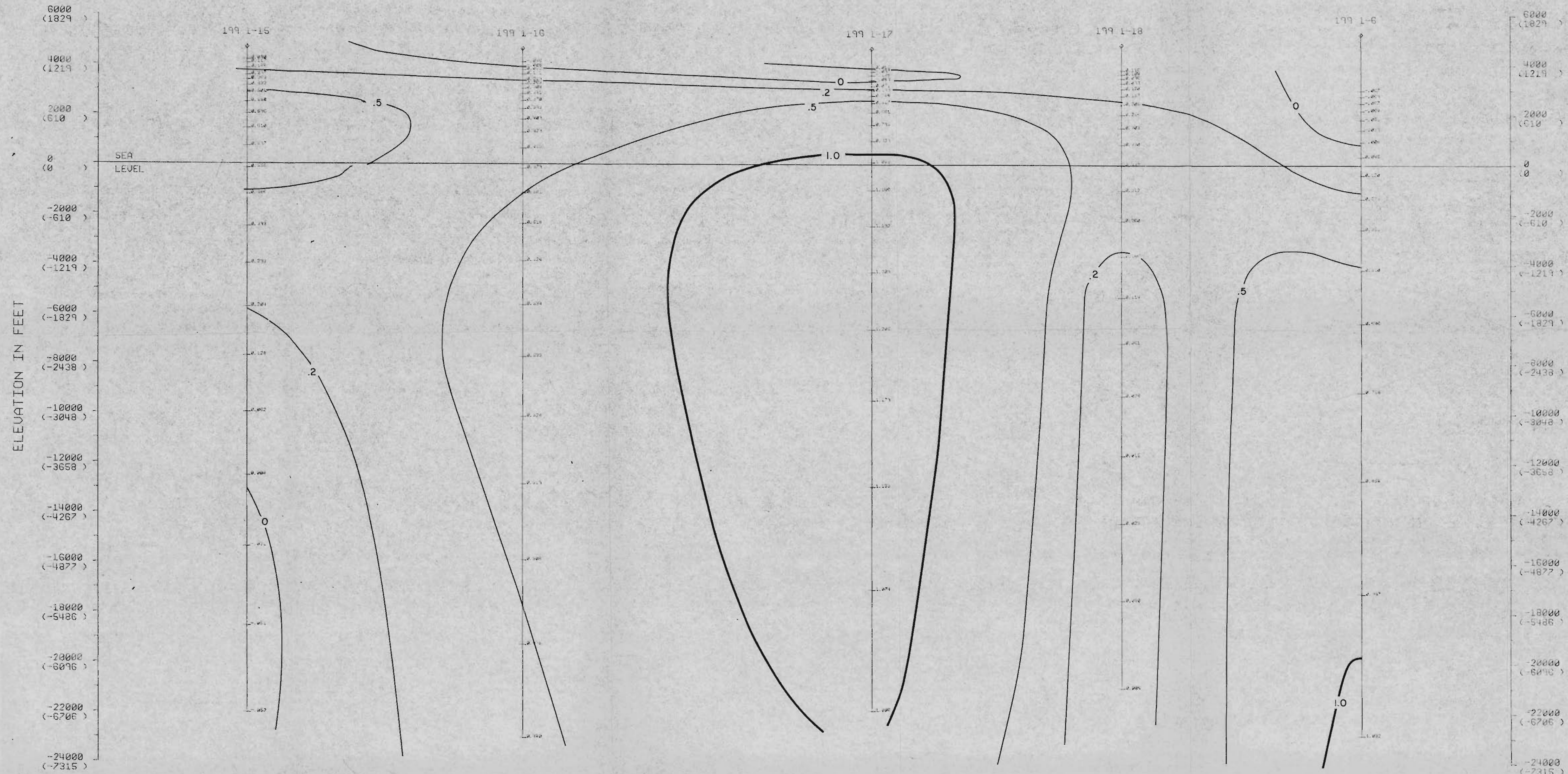

ELEVATION IN FEET

LEGEND

HORIZONTAL SCALE

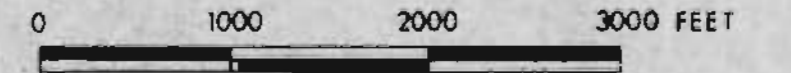

- AS=0 : ONE DIMENSIONAL
- AS>0 : RESISTIVE ANOMALY
- AS<0 : CONDUCTIVE ANOMALY

CONTOUR VALUES:
±0, .2, .5, 1.0 X 10^N

Geotronics Corp. Austin, Texas U.S.A.		
MAGNETOTELLURIC SURVEY	Survey Code	
SUNEDCO-LEACH H.S., NEV.	199	
ANISOTROPY SENSE CROSS SECTION		
LINE D		
INTERPRETER	REVISIONS	DATE
IOD		

E
WEST

E'
EAST

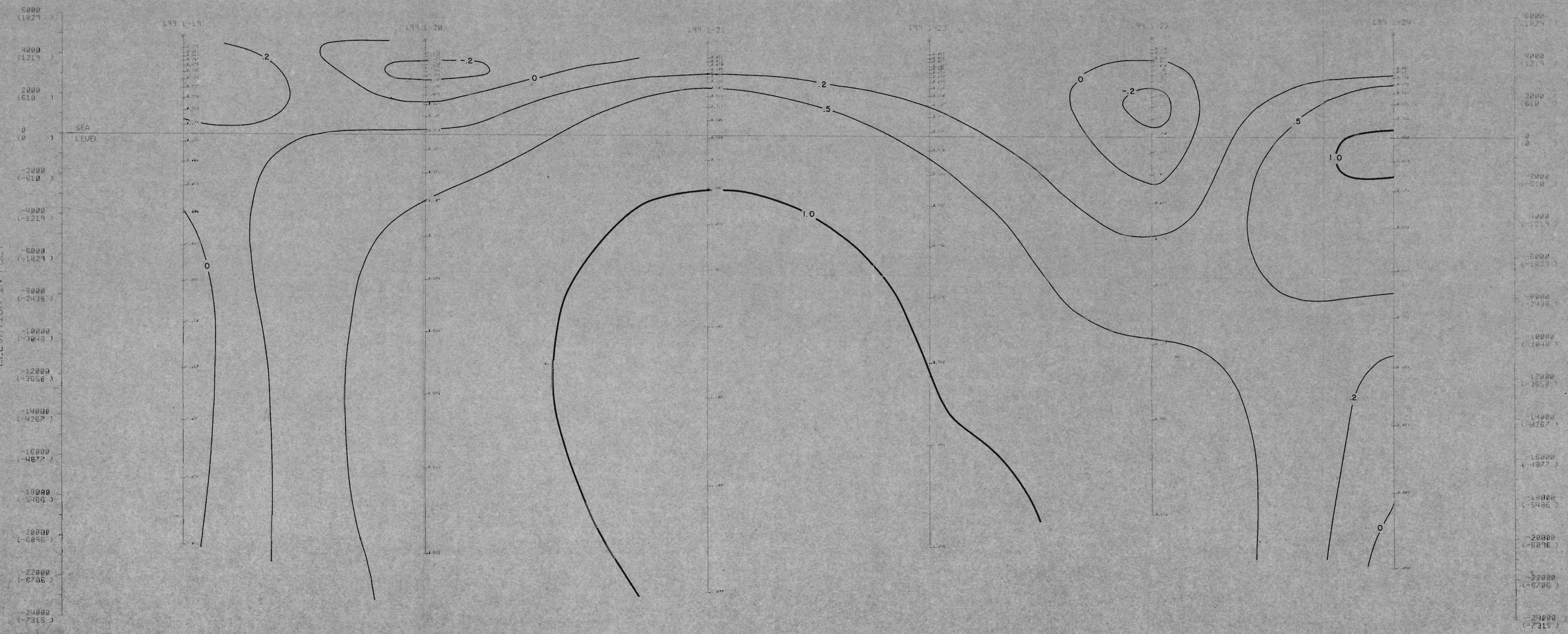

LEGEND
 HORIZONTAL SCALE:
 0 1000 2000 3000 FEET

AS=0 : ONE DIMENSIONAL
 AS>0 : RESISTIVE ANOMALY
 AS<0 : CONDUCTIVE ANOMALY

CONTOUR VALUES
 $\pm 0, 2, 5, 1.0 \times 10^N$

Geotronics Corp. Austin, Texas U.S.A.		
MAGNETOTELLURIC SURVEY	Survey Code	199
SUNEDCO-LEACH H.S., NEV.		
ANISOTROPY SENSE CROSS SECTION		
LINE E		
INTERPRETER	REVISIONS	DATE
		10E

F
WEST

F'
EAST

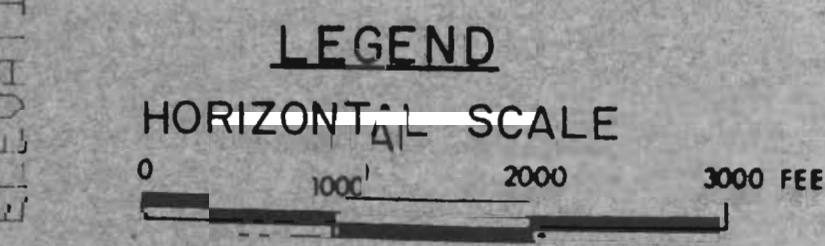
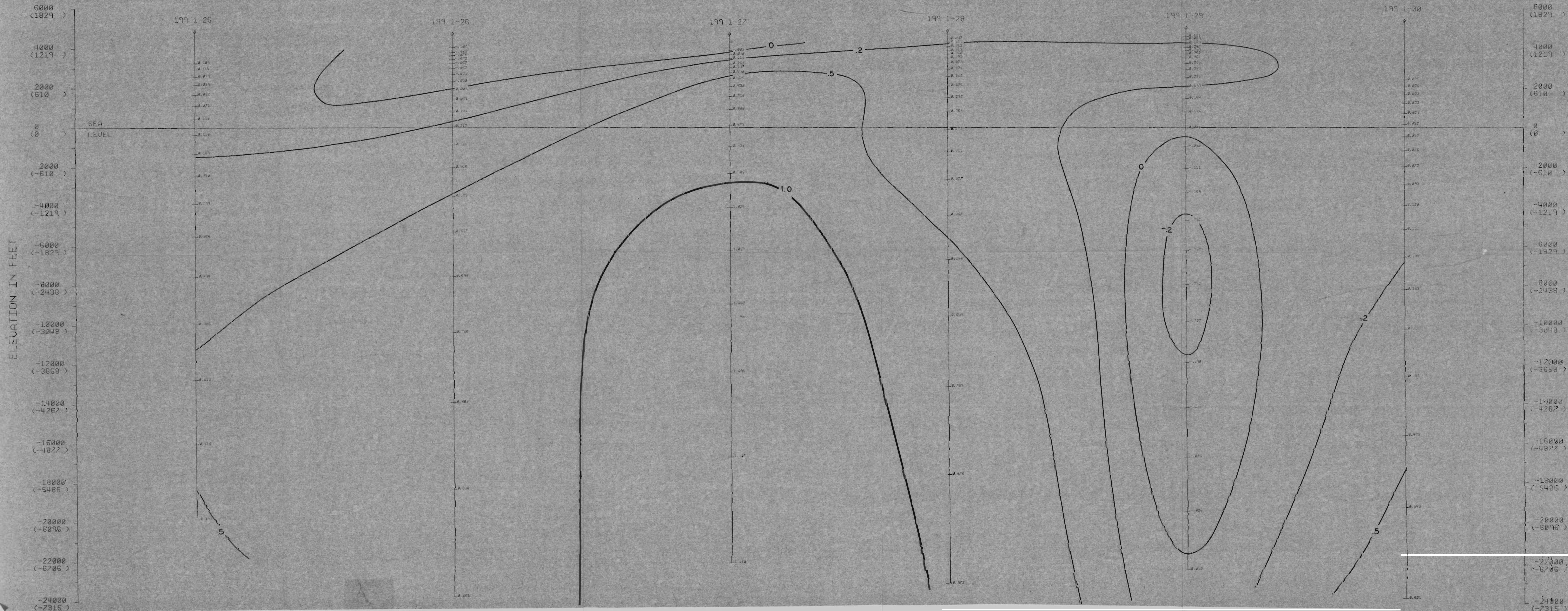

AS=0 : ONE DIMENSIONAL
 AS>0 : RESISTIVE ANOMALY
 AS<0 : CONDUCTIVE ANOMALY

CONTOUR VALUES:
 $\pm 0.2, .5, 1.0 \times 10^N$

Geotronics Corp.	
Austin, Texas U.S.A.	
MAGNETOTELURIC SURVEY	Survey No.
SUNEDCO - LEACH H.S., NEV.	199
ANISOTROPY SENSE CROSS SECTION	
LINE F	
INTERPRETER	DATE
NO. REVISIONS	DATE
ICF	

G
WEST

G'
EAST

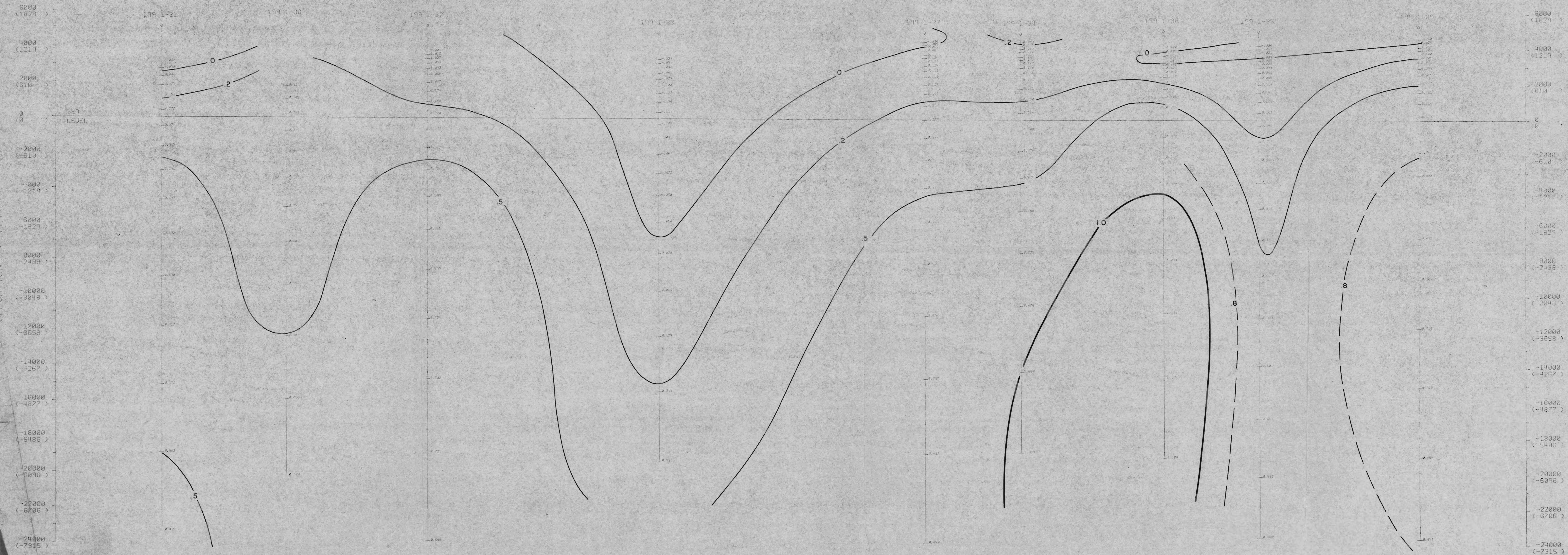

LEGEND
 HORIZONTAL SCALE

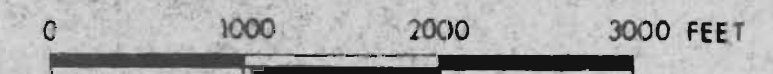

AS=0 : ONE DIMENSIONAL
 AS>0 : RESISTIVE ANOMALY
 AS<0 : CONDUCTIVE ANOMALY
 CONTOUR VALUES:
 ±0, 2, 5, 1.0 x 10^N

Geotronics Corp. Austin, Texas U.S.A.			
MAGNETOTELLURIC SURVEY		Survey Code	
SUNEDCO-LEACH H.S., NEV.		199	
ANISOTROPY SENSE CROSS SECTION			
LINE G			
INTERPRETER	REVISIONS	DATE	10G